



# GÜVEN

ELEKTRİK ELEKTRONİK LTD. ŞTİ.

**GWEST**®

**W**WOER®



**OCAK 2025**  
FİYAT LİSTESİ

## İÇİNDEKİLER

**Kablo Bağları ve Aksesuarları**

|   |    |
|---|----|
| Standart Beyaz Kablo Bağları .....            | 04 |
| Standart Siyah Kablo Bağları .....            | 05 |
| Standart Renkli Kablo Bağları .....           | 06 |
| Ultraviyole Kablo Bağları .....               | 07 |
| Paslanmaz Çelik Kablo Bağları .....           | 08 |
| PVC Kaplı Paslanmaz Çelik Kablo Bağları ..... | 09 |
| Etiketli Kablo Bağları .....                  | 10 |
| Açılabilir Kablo Bağları .....                | 10 |
| Distanslı Kablo Bağları .....                 | 10 |
| Yapışkanlı Kroşeler .....                     | 11 |
| Kapama Parçası .....                          | 11 |
| Kablo Kelepçesi .....                         | 11 |
| Kartuş Yükseltici .....                       | 12 |
| Beton Kroşe .....                             | 12 |
| Vidalı Kroşe .....                            | 12 |
| Kablo Bağı Etiket Taşıyıcı .....              | 13 |
| Yapışkanlı Pano Etiket Taşıyıcı .....         | 13 |
| Helezon Spiraller .....                       | 14 |

**Kablo Yüksükleri ve Uçları**

|   |    |
|---|----|
| İzoleli Kablo Yüksükleri Fransız Normu .....            | 16 |
| İzoleli Kablo Yüksükleri Alman Normu .....              | 17 |
| Çift Girişli Kablo Yüksükleri Fransız Normu .....       | 18 |
| Çift Girişli Kablo Yüksükleri Alman Normu .....         | 19 |
| İzolesiz Kablo Yüksükleri .....                         | 20 |
| Yuvarlak Tip İzoleli Kablo Uçları .....                 | 22 |
| Çatal Tip İzoleli Kablo Uçları .....                    | 23 |
| Ek Mufları İzoleli Kablo Uçları .....                   | 24 |
| Erkek Terminaller İzoleli Kablo Uçları .....            | 24 |
| Dişi Terminaller İzoleli Kablo Uçları .....             | 24 |
| Dişi Faston Tip İzoleli Kablo Uçları .....              | 25 |
| Tam İzoleli Dişi Faston Tip Kablo Uçları .....          | 25 |
| Tam İzoleli Polyamid Dişi Faston Tip Kablo Uçları ..... | 26 |
| İğne Tip İzoleli Kablo Uçları .....                     | 26 |
| Erkek / Dişi Geri Dönüşlü Terminaller .....             | 26 |
| Erkek Faston Tip Terminaller .....                      | 27 |
| Tam İzoleli Polyamid Bayrak Tip Terminaller .....       | 27 |
| İzolesiz Kablo Ucu ve Konnektörleri .....               | 28 |

**Bağlantı Elemanları**

|   |    |
|---|----|
| SKP Eko Tip Kablo Pabucu .....            | 30 |
| SKP Eko Tip Kablo Pabucu .....            | 31 |
| SKP Standart Tip Kablo Pabucu .....       | 32 |
| SKP Standart Tip Kablo Pabucu .....       | 33 |
| DIN 46235 Tip Kablo Pabucu .....          | 34 |
| DIN 46235 Tip Kablo Pabucu .....          | 35 |
| Bimetal (AL-CU) Kablo Pabucu .....        | 36 |
| Ek Mufları .....                          | 37 |
| Delikli Montaj Rayları .....              | 38 |
| Düz Montaj Rayları .....                  | 38 |
| Monofaze Müşterek W Otomat Baraları ..... | 39 |
| Trifaze Müşterek W Otomat Baraları .....  | 39 |
| 2 Kutuplu Dağıtıcı Üniteler .....         | 40 |
| 4 Kutuplu Dağıtıcı Üniteler .....         | 41 |
| Tek Kutuplu Dağıtıcı Üniteler .....       | 42 |
| Tek Kutuplu Dağıtıcı Üniteler .....       | 43 |

**Klemens Grubu**

|  |    |
|--|----|
| Geçmeli Buat Klemens .....   | 45 |
| Çok Amaçlı Klemens .....   | 45 |
| Ray Montajlı Klemens .....   | 46 |
| (2.5mm <sup>2</sup> ) Dağıtım Bloğu .....                                  | 46 |
| (2.5mm <sup>2</sup> ) Ray Montajlı Dağıtım Bloğu .....                     | 47 |
| 6mm <sup>2</sup> Besleme Girişli (2.5mm <sup>2</sup> ) Dağıtım Bloğu ..... | 47 |
| Ray Montaj Ayağı .....   | 47 |

**Makaron Grubu ve Bant Çeşitleri**

|  |    |
|--|----|
| Isı ile Daralan Siyah Makaronlar .....             | 49 |
| Isı ile Daralan Renkli Makaronlar .....            | 50 |
| Isı ile Daralan Kahverengi Makaronlar .....        | 51 |
| Isı ile Daralan Sarı / Yeşil Makaronlar .....      | 52 |
| İçi Yapışkanlı Daralan Makaronlar .....            | 53 |
| Kablo Toplama Çorabı .....                         | 54 |
| H Class Cam Elyaf Silikon İzoleli Makaronlar ..... | 55 |

# İÇİNDEKİLER

## Mekanik ve Hidrolik El Aletleri

|   |    |
|---|----|
| Yüksük Sıkma Penseleri .....                          | 57 |
| İzolesiz Kablo Ucu ve Konnektör Sıkma Penseleri ..... | 58 |
| İzoleli Kablo Ucu Sıkma Penseleri .....               | 58 |
| Multi Fonksiyonel Yüksük ve Kablo Ucu Sıkma Pensesi.. | 59 |
| Kablo Sıyırma Pensesi .....                           | 59 |
| Kablo Bağı Sıkma Penseleri .....                      | 59 |
| Kablo Pabucu Sıkma Penseleri .....                    | 60 |
| Hidrolik Sıkma ve Kesme Penseleri .....               | 60 |
| Kablo Kesme Makasları .....                           | 61 |

## Buton Serisi ve Aksesuarları

|   |    |
|---|----|
| Yaylı Butonlar .....                        | 63 |
| İşaretli Yaylı Butonlar .....               | 63 |
| İşikli Yaylı Butonlar .....                 | 63 |
| Kalıcı Mandal Butonlar .....                | 64 |
| Kayıcı Mandal Butonlar .....                | 64 |
| Kalıcı - Kayıcı Mandal Butonlar .....       | 64 |
| Anahtarlı Kalıcı Butonlar .....             | 64 |
| İşikli Kalıcı Mandal Butonlar .....         | 65 |
| 40mm Kalıcı Mantar Butonlar .....           | 66 |
| 40mm Kalıcı Anahtarlı Mantar Butonlar ..... | 66 |
| 40mm Kayıcı Mantar Butonlar .....           | 66 |
| İkiz Butonlar .....                         | 66 |
| Buton Serisi Aksesuarları .....             | 67 |
| Boş Kumanda Kutuları .....                  | 68 |
| Kutulu Acil Stop Buton .....                | 68 |
| Vinç Kumandaları .....                      | 69 |
| Acil Stoplu Vinç Kumandaları .....          | 69 |
| Ø 22mm Voltmetre .....                      | 70 |
| Ø 22mm Ampermetre .....                     | 70 |
| Ø 22mm Led'li Sinyaller .....               | 71 |
| Ø 16mm Led'li Sinyaller .....               | 71 |
| BA9S Led Ampuller .....                     | 72 |
| Ø 22mm Led'li Buzzer .....                  | 73 |
| Motorlu Sirenler .....                      | 73 |
| Pano İçi Termostatlar .....                 | 73 |
| Ø 22mm Potansiyometre .....                 | 74 |
| Aks Serisi Kapı Switch .....                | 74 |

## Switch Grubu

|                               |    |
|-------------------------------|----|
| GLS Serisi Limit Switch ..... | 76 |
| GLS Serisi Limit Switch ..... | 77 |
| GLS Serisi Limit Switch ..... | 78 |
| GLS Serisi Limit Switch ..... | 79 |
| AZ Serisi Mikro Switch .....  | 80 |
| AZ Serisi Mikro Switch .....  | 81 |
| GMS Serisi Mikro Switch ..... | 82 |

## Ayak Pedalları

|                             |    |
|-----------------------------|----|
| Metal Döküm Pedal .....     | 83 |
| Alüminyum Döküm Pedal ..... | 83 |



Bu fiyat listesindeki tipografik baskı hatalarından firmamız sorumlu değildir. Firmamız fiyat listesinde yayınlanmış olduğu teknik özellikleri değiştirme, döviz ve hammadde artışlarından dolayı meydana gelebilecek fiyat artışlarını hiçbir uyarıda bulunmaksızın fiyat listesine yansıtma hakkına sahiptir.

# Kalite Belgelerimiz

Güven Elektrik olarak, müşteri odaklı yaklaşımımızla, sağladığımız tüm ürün ve hizmetlerde müşteri memnuniyetini en üst düzeyde tutarak kalite ve uygunluk standartları uyguluyoruz.

Yüksek seviyede ürün kalitesini ve mevzuata uygunluğu korumak temel hedefimizdir.

Kalite, firmamız açısından tartışmasız en önemli unsurdur. En kaliteli ürünleri ortaya çıkarabilmek adına; tüm hammaddelerimizi titizlikle seçmekteyiz.



# Bizim Hakkımızda

2004 yılında karaköyde kurulan şirketimiz ürün çeşitliliğini arttırmayı ve bulunmuş olduğu sektörde sahip olduğu GWEST markasını en üst seviyeye taşımayı ilke olarak belirlemiştir. Müşterilerimize daha iyi hizmet sunabilmek için 2014 yılında İkitelli Organize Sanayi Bölgesi merkezine taşınmıştır. 2016 yılında ilk imalat tecrübesini yaşayan firmamız 2021 yılında 3000 m<sup>2</sup> kapalı alana sahip yeni yerine geçmiştir.

Firmamız uluslararası kalite standartların da gerçekleştirdiği hizmet ve üretimi ISO, CE ve TSE sertifikalarıyla da belgelendirmiştir.

Hedeflerimiz arasında olarak ürettiği ürünlerde yüksek kaliteye ulaşip ürün çeşitliliğini arttırıp ve koşulsuz müşteri memnuniyeti belirlemiştir. Bugüne kadar çalışmış olduğu müşterilerine koşulsuz müşteri memnuniyeti yaşatan Güven Elektrik hizmetlerine kalite standartlarını yükselterek devam etmektedir.



# GÜÇLÜ VE DAYANKIKLI

Tutarlı Performans ve Güvenilirlik Sağlar.







# KABLO BAĞLARI

## Ve Aksesuarları



# STANDART BEYAZ KABLO BAĞLARI

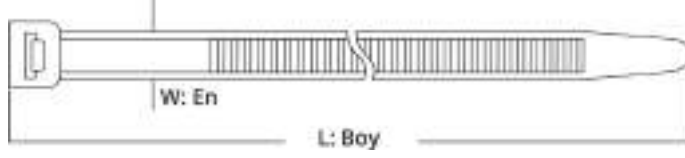

Malzeme : Saf Naylon 6.6 Standart UL  
Çalışma Sıcaklığı : - 40 ° C --- +85 ° C

| Sipariş Kodu | Ürün Kodu  | Boyutlar     |         | Renk  | Maksimum Sıkma Çapı (mm) | Açılma Mukavemeti (kg) | Ambalaj Adet |        | Birim Fiyat TL / Adet |
|--------------|------------|--------------|---------|-------|--------------------------|------------------------|--------------|--------|-----------------------|
|              |            | Uzunluk (mm) | En (mm) |       |                          |                        | Paket        | Koli   |                       |
| 1001         | GT 100 M   | 100          | 2.5     | Beyaz | 20                       | 8                      | 1.000        | 65.000 | <b>0,26</b>           |
| 1002         | GT 150 M   | 150          |         | Beyaz | 36                       |                        | 1.000        | 50.000 | <b>0,40</b>           |
| 1003         | GT 200 M   | 200          |         | Beyaz | 52                       |                        | 1.000        | 35.000 | <b>0,55</b>           |
| 1004         | GT 150 I   | 150          | 3.6     | Beyaz | 36                       | 18                     | 100          | 23.000 | <b>0,67</b>           |
| 1005         | GT 200 I   | 200          |         | Beyaz | 52                       |                        | 100          | 18.000 | <b>0,87</b>           |
| 1006         | GT 250 I   | 250          |         | Beyaz | 68                       |                        | 100          | 18.000 | <b>1,05</b>           |
| 1007         | GT 300 I   | 300          |         | Beyaz | 84                       |                        | 100          | 15.000 | <b>1,33</b>           |
| 1008         | GT 370 I   | 370          |         | Beyaz | 106                      |                        | 100          | 12.000 | <b>1,67</b>           |
| 1009         | GT 200 ST  | 200          | 4.8     | Beyaz | 50                       | 22                     | 100          | 13.000 | <b>1,24</b>           |
| 1010         | GT 250 ST  | 250          |         | Beyaz | 65                       |                        | 100          | 12.000 | <b>1,52</b>           |
| 1011         | GT 300 ST  | 300          |         | Beyaz | 81                       |                        | 100          | 11.000 | <b>1,85</b>           |
| 1012         | GT 370 ST  | 370          |         | Beyaz | 104                      |                        | 100          | 9.000  | <b>2,15</b>           |
| 1050         | GT 400 ST  | 400          |         | Beyaz | 113                      |                        | 100          | 6.000  | <b>2,45</b>           |
| 1013         | GT 430 ST  | 430          |         | Beyaz | 123                      |                        | 100          | 6.000  | <b>2,87</b>           |
| 1015         | GT 300 HD  | 300          | 7.6     | Beyaz | 76                       | 55                     | 100          | 5.000  | <b>3,80</b>           |
| 1016         | GT 370 HD  | 370          |         | Beyaz | 102                      |                        | 100          | 4.000  | <b>4,10</b>           |
| 1017         | GT 430 HD  | 430          |         | Beyaz | 110                      |                        | 100          | 3.000  | <b>4,78</b>           |
| 1018         | GT 530 HD  | 530          |         | Beyaz | 140                      |                        | 100          | 2.000  | <b>6,25</b>           |
| 1019         | GT 610 HD  | 610          |         | Beyaz | 185                      |                        | 100          | 2.000  | <b>6,90</b>           |
| 1020         | GT 750 HD  | 750          |         | Beyaz | 226                      |                        | 100          | 2.000  | <b>9,60</b>           |
| 1022         | GT 710 HD  | 710          | 9       | Beyaz | 190                      | 80                     | 100          | 2.000  | <b>10,20</b>          |
| 1023         | GT 780 HD  | 780          |         | Beyaz | 228                      |                        | 100          | 2.000  | <b>13,00</b>          |
| 1024         | GT 920 HD  | 920          |         | Beyaz | 280                      |                        | 100          | 1.500  | <b>14,70</b>          |
| 1025         | GT 1020 HD | 1020         |         | Beyaz | 295                      |                        | 100          | 1.000  | <b>15,00</b>          |
| 1026         | GT 1220 HD | 1220         |         | Beyaz | 375                      |                        | 100          | 1.000  | <b>18,80</b>          |



## STANDART SİYAH KABLO BAĞLARI

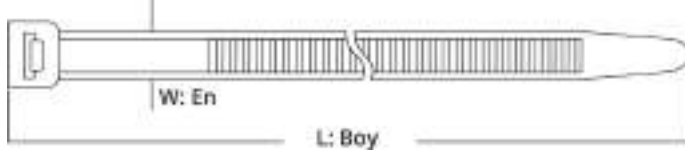

Malzeme : Saf Naylon 6.6 Standart UL  
Çalışma Sıcaklığı : - 40 ° C --- +85 ° C

| Sipariş Kodu | Ürün Kodu  | Boyutlar     |         | Renk  | Maksimum Sıkma Çapı (mm) | Açılma Mukavemeti (kg) | Ambalaj Adet |        | Birim Fiyat TL / Adet |
|--------------|------------|--------------|---------|-------|--------------------------|------------------------|--------------|--------|-----------------------|
|              |            | Uzunluk (mm) | En (mm) |       |                          |                        | Paket        | Koli   |                       |
| 1027         | GT 100 MB  | 100          | 2.5     | Siyah | 20                       | 8                      | 1.000        | 65.000 | <b>0,26</b>           |
| 1028         | GT 150 MB  | 150          |         | Siyah | 36                       |                        | 1.000        | 50.000 | <b>0,40</b>           |
| 1029         | GT 200 MB  | 200          |         | Siyah | 52                       |                        | 1.000        | 35.000 | <b>0,55</b>           |
| 1030         | GT 150 IB  | 150          | 3.6     | Siyah | 36                       | 18                     | 100          | 23.000 | <b>0,67</b>           |
| 1031         | GT 200 IB  | 200          |         | Siyah | 52                       |                        | 100          | 18.000 | <b>0,87</b>           |
| 1032         | GT 250 IB  | 250          |         | Siyah | 68                       |                        | 100          | 18.000 | <b>1,05</b>           |
| 1033         | GT 300 IB  | 300          |         | Siyah | 84                       |                        | 100          | 15.000 | <b>1,33</b>           |
| 1034         | GT 370 IB  | 370          |         | Siyah | 106                      |                        | 100          | 12.000 | <b>1,67</b>           |
| 1035         | GT 200 STB | 200          | 4.8     | Siyah | 50                       | 22                     | 100          | 13.000 | <b>1,24</b>           |
| 1036         | GT 250 STB | 250          |         | Siyah | 65                       |                        | 100          | 12.000 | <b>1,52</b>           |
| 1037         | GT 300 STB | 300          |         | Siyah | 81                       |                        | 100          | 11.000 | <b>1,85</b>           |
| 1038         | GT 370 STB | 370          |         | Siyah | 104                      |                        | 100          | 9.000  | <b>2,15</b>           |
| 1039         | GT 430 STB | 430          |         | Siyah | 123                      |                        | 100          | 6.000  | <b>2,87</b>           |
| 1041         | GT 300 HDB | 300          | 7.6     | Siyah | 76                       | 55                     | 100          | 5.000  | <b>3,80</b>           |
| 1042         | GT 370 HDB | 370          |         | Siyah | 102                      |                        | 100          | 4.000  | <b>4,10</b>           |
| 1043         | GT 430 HDB | 430          |         | Siyah | 110                      |                        | 100          | 3.000  | <b>4,78</b>           |
| 1044         | GT 530 HDB | 530          |         | Siyah | 140                      |                        | 100          | 2.000  | <b>6,25</b>           |
| 1045         | GT 610 HDB | 610          |         | Siyah | 185                      |                        | 100          | 2.000  | <b>6,90</b>           |
| 1046         | GT 750 HDB | 750          |         | Siyah | 226                      |                        | 100          | 2.000  | <b>9,60</b>           |
| 1048         | GT 710 HDB | 710          | 9       | Siyah | 190                      | 80                     | 100          | 2.000  | <b>10,20</b>          |
| 1049         | GT 780 HDB | 780          |         | Siyah | 228                      |                        | 100          | 2.000  | <b>13,00</b>          |
| 1051         | GT 920 HDB | 920          |         | Siyah | 280                      |                        | 100          | 1.500  | <b>14,70</b>          |

# STANDART RENKLİ KABLO BAĞLARI

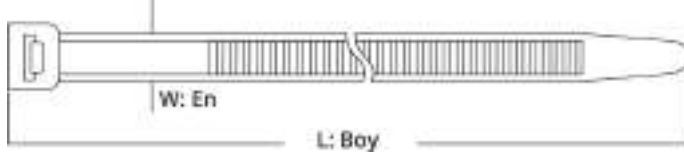

Malzeme : Saf Naylon 6.6 Standart UL  
Çalışma Sıcaklığı : - 40 ° C --- +85 ° C

| Sipariş Kodu | Ürün Kodu  | Boyutlar     |         | Renk    | Maksimum Sıkma Çapı (mm) | Açılma Mukavemeti (kg) | Ambalaj Adet |        | Birim Fiyat TL / Adet |
|--------------|------------|--------------|---------|---------|--------------------------|------------------------|--------------|--------|-----------------------|
|              |            | Uzunluk (mm) | En (mm) |         |                          |                        | Paket        | Koli   |                       |
| 1101         | GT 100 MK  | 100          | 2.5     | Kırmızı | 20                       | 8                      | 1.000        | 65.000 | 0,29                  |
| 1102         | GT 150 IK  | 150          | 3.6     | Kırmızı | 36                       | 18                     | 100          | 23.000 | 0,70                  |
| 1103         | GT 200 IK  | 200          |         | Kırmızı | 52                       |                        | 100          | 18.000 | 0,96                  |
| 1104         | GT 250 IK  | 250          |         | Kırmızı | 68                       |                        | 100          | 18.000 | 1,15                  |
| 1105         | GT 300 IK  | 300          |         | Kırmızı | 84                       |                        | 100          | 15.000 | 1,45                  |
| 1106         | GT 200 STK | 200          |         | Kırmızı | 50                       |                        | 22           | 100    | 13.000                |
| 1107         | GT 250 STK | 250          | Kırmızı | 65      | 100                      | 12.000                 |              | 1,65   |                       |
| 1108         | GT 300 STK | 300          | Kırmızı | 81      | 100                      | 11.000                 |              | 2,00   |                       |
| 1109         | GT 370 STK | 370          | Kırmızı | 101     | 100                      | 9.000                  |              | 2,35   |                       |
| 1110         | GT 100 MM  | 100          | 2.5     | Mavi    | 20                       | 8                      |              | 1.000  | 65.000                |
| 1111         | GT 150 IM  | 150          | 3.6     | Mavi    | 36                       | 18                     | 100          | 23.000 | 0,70                  |
| 1112         | GT 200 IM  | 200          |         | Mavi    | 52                       |                        | 100          | 18.000 | 0,96                  |
| 1113         | GT 250 IM  | 250          |         | Mavi    | 68                       |                        | 100          | 18.000 | 1,15                  |
| 1114         | GT 300 IM  | 300          |         | Mavi    | 84                       |                        | 100          | 15.000 | 1,45                  |
| 1115         | GT 200 STM | 200          |         | Mavi    | 50                       |                        | 22           | 100    | 13.000                |
| 1116         | GT 250 STM | 250          | Mavi    | 65      | 100                      | 12.000                 |              | 1,65   |                       |
| 1117         | GT 300 STM | 300          | Mavi    | 81      | 100                      | 11.000                 |              | 2,00   |                       |
| 1118         | GT 370 STM | 370          | Mavi    | 101     | 100                      | 9.000                  |              | 2,35   |                       |
| 1119         | GT 100 MS  | 100          | 2.5     | Sarı    | 20                       | 8                      |              | 1.000  | 65.000                |
| 1120         | GT 150 IS  | 150          | 3.6     | Sarı    | 36                       | 18                     | 100          | 23.000 | 0,70                  |
| 1121         | GT 200 IS  | 200          |         | Sarı    | 52                       |                        | 100          | 18.000 | 0,96                  |
| 1122         | GT 250 IS  | 250          |         | Sarı    | 68                       |                        | 100          | 18.000 | 1,15                  |
| 1123         | GT 300 IS  | 300          |         | Sarı    | 84                       |                        | 100          | 15.000 | 1,45                  |
| 1124         | GT 200 STS | 200          |         | Sarı    | 50                       |                        | 22           | 100    | 13.000                |
| 1125         | GT 250 STS | 250          | Sarı    | 65      | 100                      | 12.000                 |              | 1,65   |                       |
| 1126         | GT 300 STS | 300          | Sarı    | 81      | 100                      | 11.000                 |              | 2,00   |                       |
| 1127         | GT 370 STS | 370          | Sarı    | 104     | 100                      | 9.000                  |              | 2,35   |                       |
| 1128         | GT 100 MY  | 100          | 2.5     | Yeşil   | 20                       | 8                      |              | 1.000  | 65.000                |
| 1129         | GT 150 IY  | 150          | 3.6     | Yeşil   | 36                       | 18                     | 100          | 23.000 | 0,70                  |
| 1130         | GT 200 IY  | 200          |         | Yeşil   | 52                       |                        | 100          | 18.000 | 0,96                  |
| 1131         | GT 250 IY  | 250          |         | Yeşil   | 68                       |                        | 100          | 18.000 | 1,15                  |
| 1132         | GT 300 IY  | 300          |         | Yeşil   | 84                       |                        | 100          | 15.000 | 1,45                  |
| 1133         | GT 200 STY | 200          |         | Yeşil   | 50                       |                        | 22           | 100    | 13.000                |
| 1134         | GT 250 STY | 250          | Yeşil   | 65      | 100                      | 12.000                 |              | 1,65   |                       |
| 1135         | GT 300 STY | 300          | Yeşil   | 81      | 100                      | 11.000                 |              | 2,00   |                       |
| 1136         | GT 370 STY | 370          | Yeşil   | 101     | 100                      | 9.000                  |              | 2,35   |                       |

## ULTRAVİOLE KABLO BAĞLARI

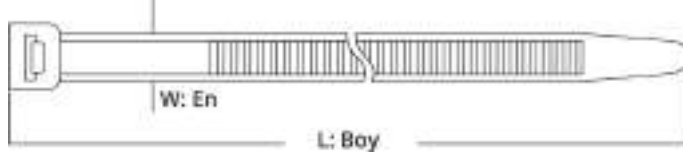

Malzeme : Saf Naylon 6.6 Standart UL  
Çalışma Sıcaklığı : - 40 ° C --- +85 ° C

| Sipariş Kodu | Ürün Kodu    | Boyutlar     |         | Renk  | Maksimum Sıkma Çapı (mm) | Açılma Mukavemeti (kg) | Ambalaj Adet |        | Birim Fiyat TL / Adet |
|--------------|--------------|--------------|---------|-------|--------------------------|------------------------|--------------|--------|-----------------------|
|              |              | Uzunluk (mm) | En (mm) |       |                          |                        | Paket        | Koli   |                       |
| 1201         | GT 100 M UV  | 100          | 2.5     | Siyah | 20                       | 8                      | 1.000        | 65.000 | 0,29                  |
| 1202         | GT 150 M UV  | 150          |         | Siyah | 36                       |                        | 1.000        | 50.000 | 0,43                  |
| 1203         | GT 200 M UV  | 200          |         | Siyah | 52                       |                        | 1.000        | 35.000 | 0,63                  |
| 1204         | GT 150 I UV  | 150          | 3.6     | Siyah | 36                       | 18                     | 100          | 23.000 | 0,72                  |
| 1205         | GT 200 I UV  | 200          |         | Siyah | 52                       |                        | 100          | 18.000 | 0,98                  |
| 1206         | GT 250 I UV  | 250          |         | Siyah | 68                       |                        | 100          | 18.000 | 1,18                  |
| 1207         | GT 300 I UV  | 300          |         | Siyah | 84                       |                        | 100          | 15.000 | 1,43                  |
| 1208         | GT 200 ST UV | 200          | 4.8     | Siyah | 50                       | 22                     | 100          | 13.000 | 1,35                  |
| 1209         | GT 250 ST UV | 250          |         | Siyah | 65                       |                        | 100          | 12.000 | 1,65                  |
| 1210         | GT 300 ST UV | 300          |         | Siyah | 81                       |                        | 100          | 11.000 | 2,05                  |
| 1211         | GT 370 ST UV | 370          |         | Siyah | 104                      |                        | 100          | 9.000  | 2,35                  |
| 1212         | GT 430 ST UV | 430          | 7.6     | Siyah | 123                      | 55                     | 100          | 6.000  | 3,15                  |
| 1213         | GT 300 HD UV | 300          |         | Siyah | 76                       |                        | 100          | 5.000  | 4,15                  |
| 1214         | GT 370 HD UV | 370          |         | Siyah | 102                      |                        | 100          | 4.000  | 4,50                  |
| 1215         | GT 430 HD UV | 430          |         | Siyah | 110                      |                        | 100          | 3.000  | 5,20                  |
| 1216         | GT 530 HD UV | 530          | 9       | Siyah | 140                      | 80                     | 100          | 2.000  | 6,90                  |
| 1217         | GT 780 HD UV | 780          |         | Siyah | 228                      |                        | 100          | 2.000  | 14,20                 |



## PASLANMAZ ÇELİK KABLO BAĞLARI

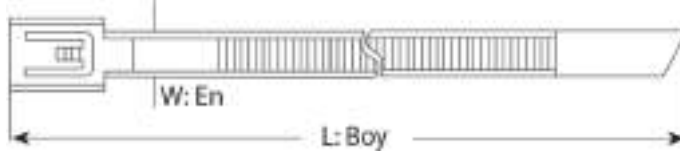

Malzeme : 304 Paslanmaz Çelik  
Su Emilimi: Yok  
Alev Yürümeme : UL94V-2

| Sipariş Kodu | Ürün Kodu  | Boyutlar     |         | Renk  | Maksimum Sıkma Çapı (mm) | Açılma Mukavemeti (kg) | Ambalaj Adet |       | Birim Fiyat TL / Adet |
|--------------|------------|--------------|---------|-------|--------------------------|------------------------|--------------|-------|-----------------------|
|              |            | Uzunluk (mm) | En (mm) |       |                          |                        | Paket        | Koli  |                       |
| 1301         | MTL 150 ST | 150          | 4.6     | Metal | 44                       | 55                     | 100          | 8.000 | <b>3,80</b>           |
| 1302         | MTL 200 ST | 200          |         | Metal | 51                       |                        | 100          | 6.000 | <b>4,30</b>           |
| 1303         | MTL 260 ST | 260          |         | Metal | 69                       |                        | 100          | 5.000 | <b>4,90</b>           |
| 1304         | MTL 300 ST | 300          |         | Metal | 76                       |                        | 100          | 5.000 | <b>5,20</b>           |
| 1305         | MTL 370 ST | 370          |         | Metal | 102                      |                        | 100          | 4.000 | <b>5,70</b>           |
| 1306         | MTL 520 ST | 520          |         | Metal | 152                      |                        | 100          | 3.000 | <b>7,20</b>           |
| 1307         | MTL 680 ST | 680          |         | Metal | 203                      |                        | 100          | 2.000 | <b>8,80</b>           |
| 1308         | MTL 840 ST | 840          |         | Metal | 254                      |                        | 100          | 1.000 | <b>10,50</b>          |
| 1309         | MTL 200 HD | 200          | 7.9     | Metal | 50                       | 120                    | 100          | 5.000 | <b>6,70</b>           |
| 1310         | MTL 300 HD | 300          |         | Metal | 75                       |                        | 100          | 4.000 | <b>7,80</b>           |
| 1311         | MTL 370 HD | 370          |         | Metal | 102                      |                        | 100          | 3.000 | <b>9,00</b>           |
| 1312         | MTL 520 HD | 520          |         | Metal | 152                      |                        | 100          | 2.000 | <b>11,50</b>          |
| 1313         | MTL 680 HD | 680          |         | Metal | 203                      |                        | 100          | 2.000 | <b>13,20</b>          |
| 1314         | MTL 840 HD | 840          |         | Metal | 224                      |                        | 100          | 1.000 | <b>16,50</b>          |

### Paslanmaz Çelik Kablo Bağları

- Kendiliğinden kilitlenebilir kafa tasarımı, kurulumu hızlandırır ve kablo bağı gövdesi boyunca herhangi bir boyda kilitlemeyi sağlar.
- Güçlü ve dayanıklı kablo bağlama yöntemini temin eder.
- Çok çeşitli iç mekân ve dış mekân uygulama alanlarında kullanılabilir.
- Pürüzsüz yüzeyi ve yuvarlatılmış uçları ile kabloların korunmasını ve çalışan kişinin güvenliğini garanti eder.
- Şebeke kablolarında en üst düzey desteği sağlar.
- Genel amaçlı uygulamalar için : 304 paslanmaz çelik



## PVC KAPLI PASLANMAZ ÇELİK KABLO BAĞLARI

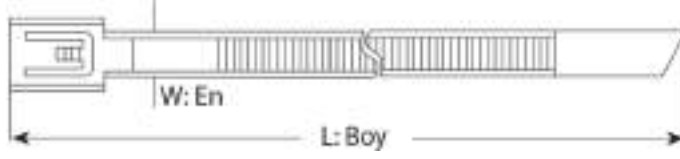

Malzeme : 304 Paslanmaz Çelik  
Su Emilimi: Yok  
Alev Yürümeme : UL94V-2

| Sipariş Kodu | Ürün Kodu      | Boyutlar     |         | Renk  | Maksimum Sıkma Çapı (mm) | Açılma Mukavemeti (kg) | Ambalaj Adet |       | Birim Fiyat TL / Adet |
|--------------|----------------|--------------|---------|-------|--------------------------|------------------------|--------------|-------|-----------------------|
|              |                | Uzunluk (mm) | En (mm) |       |                          |                        | Paket        | Koli  |                       |
| 1401         | PVC MTL 150 ST | 150          | 4.6     | Metal | 44                       | 55                     | 100          | 8.000 | 5,80                  |
| 1402         | PVC MTL 200 ST | 200          |         | Metal | 51                       |                        | 100          | 6.000 | 6,40                  |
| 1403         | PVC MTL 260 ST | 260          |         | Metal | 69                       |                        | 100          | 5.000 | 7,00                  |
| 1404         | PVC MTL 300 ST | 300          |         | Metal | 76                       |                        | 100          | 5.000 | 7,70                  |
| 1405         | PVC MTL 370 ST | 370          |         | Metal | 102                      |                        | 100          | 4.000 | 9,40                  |
| 1406         | PVC MTL 520 ST | 520          |         | Metal | 152                      |                        | 100          | 3.000 | 12,20                 |
| 1407         | PVC MTL 680 ST | 680          |         | Metal | 203                      |                        | 100          | 2.000 | 14,20                 |
| 1408         | PVC MTL 840 ST | 840          |         | Metal | 254                      |                        | 100          | 1.000 | 19,00                 |
| 1409         | PVC MTL 200 HD | 200          | 7.9     | Metal | 50                       | 120                    | 100          | 5.000 | 8,50                  |
| 1410         | PVC MTL 300 HD | 300          |         | Metal | 75                       |                        | 100          | 4.000 | 11,00                 |
| 1411         | PVC MTL 370 HD | 370          |         | Metal | 102                      |                        | 100          | 3.000 | 12,20                 |
| 1412         | PVC MTL 520 HD | 520          |         | Metal | 152                      |                        | 100          | 2.000 | 16,50                 |
| 1413         | PVC MTL 680 HD | 680          |         | Metal | 203                      |                        | 100          | 2.000 | 21,00                 |
| 1414         | PVC MTL 840 HD | 840          |         | Metal | 224                      |                        | 100          | 1.000 | 25,00                 |

## PVC Kaplı Paslanmaz Çelik Kablo Bağları

- Kendiliğinden kilitlenebilir kafa tasarımı, kurulumu hızlandırır ve kablo bağı gövdesi boyunca herhangi bir boyda kilitlemeyi sağlar.
- Güçlü ve dayanıklı kablo bağlama yöntemini temin eder.
- Çok çeşitli iç mekân ve dış mekân uygulama alanlarında kullanılabilir.
- Pürüzsüz yüzeyi ve yuvarlatılmış uçları ile kablunun korunmasını ve çalışan kişinin güvenliğini garanti eder.
- Şebeke kablolarında en üst düzey desteği sağlar.
- Genel amaçlı uygulamalar için : 304 paslanmaz çelik





## ETİKETLİ KABLO BAĞLARI

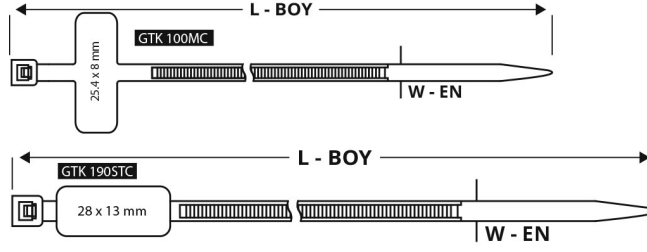

Malzeme : Saf Naylon 6.6 Standart UL  
Çalışma Sıcaklığı : - 40 ° C --- +85 ° C

| Sipariş Kodu | Ürün Kodu   | Boyutlar     |         | Renk  | Maksimum Sıkma Çapı (mm) | Açılma Mukavemeti (kg) | Ambalaj Adet |        | Birim Fiyat TL / Adet |
|--------------|-------------|--------------|---------|-------|--------------------------|------------------------|--------------|--------|-----------------------|
|              |             | Uzunluk (mm) | En (mm) |       |                          |                        | Paket        | Koli   |                       |
| 1501         | GTK 100 MC  | 100          | 2.5     | Beyaz | 20                       | 8                      | 100          | 30.000 | <b>0,93</b>           |
| 1502         | GTK 190 STC | 190          | 4.8     | Beyaz | 48                       | 22                     | 100          | 15.000 | <b>2,00</b>           |

## AÇILABİLİR KABLO BAĞLARI

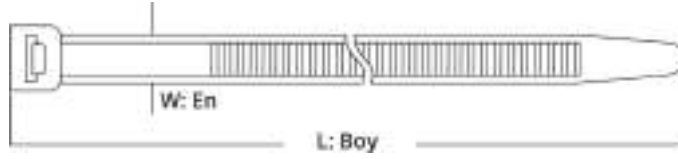

Malzeme : Saf Naylon 6.6 Standart UL  
Çalışma Sıcaklığı : - 40 ° C --- +85 ° C

| Sipariş Kodu | Ürün Kodu  | Boyutlar     |         | Renk  | Maksimum Sıkma Çapı (mm) | Açılma Mukavemeti (kg) | Ambalaj Adet |       | Birim Fiyat TL / Adet |
|--------------|------------|--------------|---------|-------|--------------------------|------------------------|--------------|-------|-----------------------|
|              |            | Uzunluk (mm) | En (mm) |       |                          |                        | Paket        | Koli  |                       |
| 1503         | GTA 200 HD | 200          | 7.6     | Beyaz | 50                       | 36                     | 100          | 2.000 | <b>3,00</b>           |
| 1504         | GTA 370 HD | 370          | 7.6     | Beyaz | 100                      | 36                     | 100          | 2.000 | <b>5,00</b>           |

## DİSTANSLI KABLO BAĞLARI

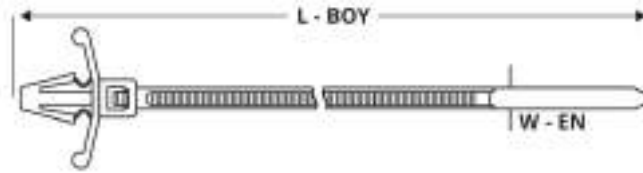

Malzeme : Saf Naylon 6.6 Standart UL  
Çalışma Sıcaklığı : - 40 ° C --- +85 ° C

| Sipariş Kodu | Ürün Kodu  | Boyutlar     |         | Renk  | Maksimum Sıkma Çapı (mm) | Açılma Mukavemeti (kg) | Ambalaj Adet |        | Birim Fiyat TL / Adet |
|--------------|------------|--------------|---------|-------|--------------------------|------------------------|--------------|--------|-----------------------|
|              |            | Uzunluk (mm) | En (mm) |       |                          |                        | Paket        | Koli   |                       |
| 1505         | GTP 100 M  | 100          | 2.5     | Beyaz | 20                       | 8                      | 100          | 15.000 | <b>0,90</b>           |
| 1506         | GTP 150 I  | 150          | 3.6     | Beyaz | 35                       | 18                     | 100          | 10.000 | <b>1,25</b>           |
| 1507         | GTP 200 ST | 200          | 4.8     | Beyaz | 50                       | 22                     | 100          | 5.000  | <b>2,60</b>           |

## YAPIŞKANLI KROŞE

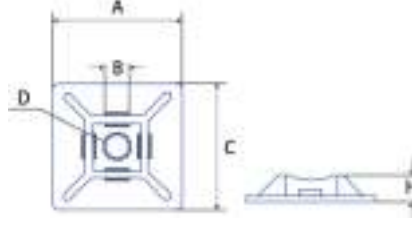
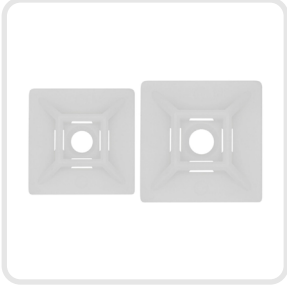

Malzeme : Saf Naylon 6.6 Standart UL  
Çalışma Sıcaklığı : - 40 ° C --- +85 ° C

| Sipariş Kodu | Ürün Kodu | Boyutlar |    |     |       |     | Renk  | Ambalaj Adet |        | Birim Fiyat TL / Adet |
|--------------|-----------|----------|----|-----|-------|-----|-------|--------------|--------|-----------------------|
|              |           | A        | B  | C   | D     | H   |       | Paket        | Koli   |                       |
| 1513         | HW - 3A   | 19       | 19 | 3.6 | Ø 3.2 | 4.0 | Beyaz | 100          | 20.000 | 1,25                  |
| 1514         | HW - 4A   | 28       | 28 | 4.8 | Ø 3.2 | 4.5 | Beyaz | 100          | 9.000  | 2,20                  |
| 1515         | HW - 3AB  | 19       | 19 | 3.6 | Ø 3.2 | 4.0 | Siyah | 100          | 20.000 | 1,25                  |
| 1516         | HW - 4AB  | 28       | 28 | 4.8 | Ø 3.2 | 4.5 | Siyah | 100          | 9.000  | 2,20                  |

## KAPAMA PARÇASI

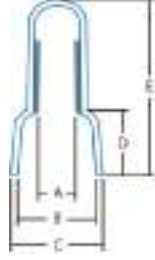

Malzeme : Saf Naylon 6.6 Standart UL  
Çalışma Sıcaklığı : - 40 ° C --- +85 ° C

| Sipariş Kodu | Ürün Kodu | Boyutlar |    |     |       |     | Renk  | Ambalaj Adet |        | Birim Fiyat TL / Adet |
|--------------|-----------|----------|----|-----|-------|-----|-------|--------------|--------|-----------------------|
|              |           | A        | B  | C   | D     | H   |       | Paket        | Koli   |                       |
| 1517         | HW - C4   | 19       | 19 | 3.6 | Ø 3.2 | 4.0 | Beyaz | 100          | 20.000 | 0,65                  |
| 1518         | HW - C5   | 28       | 28 | 4.8 | Ø 3.2 | 4.5 | Beyaz | 100          | 10.000 | 1,15                  |

## KABLO KELEPÇESİ

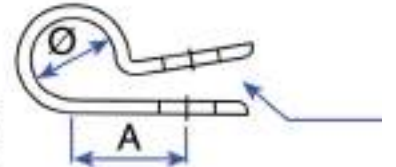
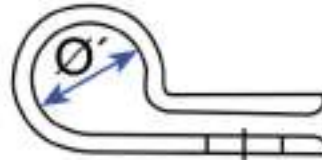
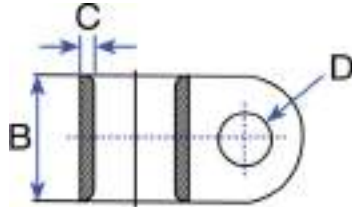

| Sipariş Kodu | Ürün Kodu | Boyutlar |     |      |     |      |    | Renk  | Ambalaj Adet |        | Birim Fiyat TL / Adet |
|--------------|-----------|----------|-----|------|-----|------|----|-------|--------------|--------|-----------------------|
|              |           | Ø        | Ø1  | A    | B   | C    | D  |       | Paket        | Koli   |                       |
| 1523         | GCL 1/4   | 7.4      | 6.6 | 10.3 | 9.1 | 1.27 | M5 | Beyaz | 100          | 20.000 | 0,90                  |
| 1524         | GCL 3/8   | 10.9     | 9.7 | 11.9 | 9.2 | 1.27 | M5 | Beyaz | 100          | 10.000 | 1,10                  |

## KARTUŞ YÜKSELTİCİ

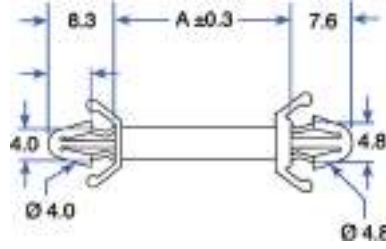
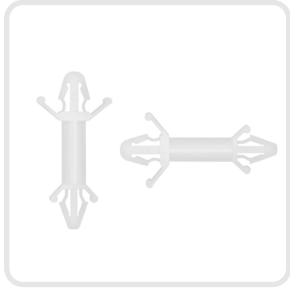

Malzeme : Saf Naylon 6.6 Standart UL  
Çalışma Sıcaklığı : - 40 ° C --- +85 ° C

| Sipariş Kodu | Ürün Kodu | Boyutlar |  | Renk  | Ambalaj Adet |        | Birim Fiyat TL / Adet |
|--------------|-----------|----------|--|-------|--------------|--------|-----------------------|
|              |           | A        |  |       | Paket        | Koli   |                       |
| 1519         | CBS - 9A  | 9.2      |  | Beyaz | 1.000        | 25.000 | <b>1,20</b>           |
| 1520         | CBS - 13A | 12.6     |  | Beyaz | 1.000        | 25.000 | <b>1,25</b>           |

## BETON KROŞE

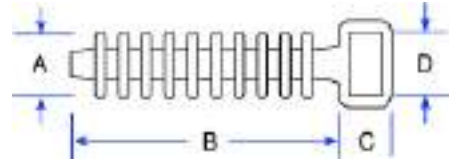

| Sipariş Kodu | Ürün Kodu | Boyutlar |      |     |     | Maksimum Sıkma Çapı (mm) | Renk  | Ambalaj Adet |       | Birim Fiyat TL / Adet |
|--------------|-----------|----------|------|-----|-----|--------------------------|-------|--------------|-------|-----------------------|
|              |           | A        | B    | C   | D   |                          |       | Paket        | Koli  |                       |
| 1525         | TH - 2    | 9.5      | 36.0 | 6.0 | 9.5 | 9.5                      | Siyah | 100          | 8.000 | <b>1,75</b>           |

## VİDALI KROŞE

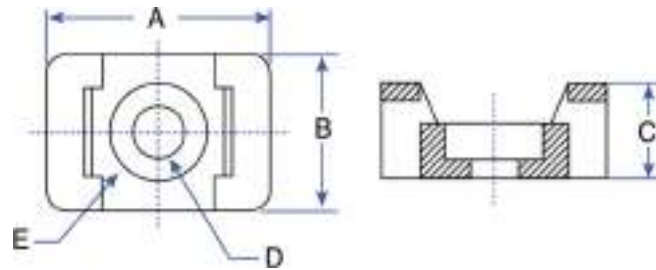

| Sipariş Kodu | Ürün Kodu | Boyutlar |      |     |     |      | Maksimum Sıkma Çapı (mm) | Renk  | Ambalaj Adet |        | Birim Fiyat TL / Adet |
|--------------|-----------|----------|------|-----|-----|------|--------------------------|-------|--------------|--------|-----------------------|
|              |           | A        | B    | C   | D   | E    |                          |       | Paket        | Koli   |                       |
| 1511         | VK V - 1  | 14.9     | 9.5  | 6.9 | 4.5 | 7.8  | 4.8                      | Beyaz | 100          | 20.000 | <b>1,05</b>           |
| 1512         | VK V - 2  | 22.2     | 15.9 | 9.7 | 6.4 | 12.6 | 7.6                      | Beyaz | 100          | 10.000 | <b>1,50</b>           |

## KABLO BAĞI ETİKET TAŞIYICI

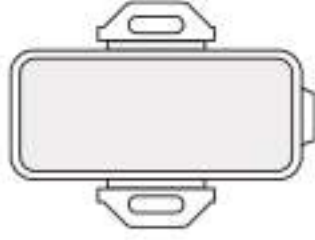

Malzeme : Polipropilen

Çalışma Sıcaklığı : 0 ° C --- +90 ° C

| Sipariş Kodu | Ürün Kodu | Boyutlar |    |   | Etiket Eni (mm) | Etiket Boyu (mm) | Renk  | Ambalaj Adet |       | Birim Fiyat TL / Adet |
|--------------|-----------|----------|----|---|-----------------|------------------|-------|--------------|-------|-----------------------|
|              |           | A        | B  | C |                 |                  |       | Paket        | Koli  |                       |
| 1526         | GET - 1   | 35       | 10 | 8 | 32              | 7                | Beyaz | 100          | 8.000 | <b>2,30</b>           |
| 1527         | GET - 2   | 45       | 20 | 8 | 42              | 17               | Beyaz | 100          | 4.000 | <b>4,10</b>           |

## YAPIŞKANLI PANO ETİKET TAŞIYICI

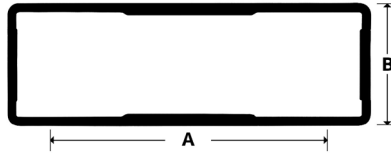

Malzeme : ABS Altılık, PS Kapak +

Çift Taraflı Bant

Çalışma Sıcaklığı : -40 ° C --- +60 ° C

| Sipariş Kodu | Ürün Kodu | Boyutlar |    | Etiket Eni (mm) | Etiket Boyu (mm) | Renk  | Ambalaj Adet |       | Birim Fiyat TL / Adet |
|--------------|-----------|----------|----|-----------------|------------------|-------|--------------|-------|-----------------------|
|              |           | A        | B  |                 |                  |       | Paket        | Koli  |                       |
| 1528         | GPET - 1  | 30       | 17 | 27,5            | 14,4             | Siyah | 100          | 8.000 | <b>2,90</b>           |
| 1529         | GPET - 2  | 50       | 17 | 49              | 15               | Siyah | 50           | 5.000 | <b>3,90</b>           |
| 1530         | GPET - 3  | 75       | 17 | 72              | 15               | Siyah | 25           | 3.000 | <b>5,30</b>           |

## HELEZON SPİRALLER

| Sipariş Kodu | Ürün Kodu   | O.D. | T    | W    | Kablo Kesit (mm <sup>2</sup> ) | Renk  | Paket Miktarı (Mt.) | Koli Miktarı (Mt.) | Birim Fiyat TL / Adet |
|--------------|-------------|------|------|------|--------------------------------|-------|---------------------|--------------------|-----------------------|
| 3251         | GHS6 (No1)  | 6    | 0.60 | 7.4  | 2.5 - 15                       | Beyaz | 10                  | 1.000              | <b>7,00</b>           |
| 3252         | GHS8 (No2)  | 8    | 0.75 | 12   | 6 - 30                         | Beyaz | 10                  | 800                | <b>9,30</b>           |
| 3253         | GHS10 (No3) | 10   | 0.80 | 12.3 | 7.5 - 30                       | Beyaz | 10                  | 500                | <b>11,00</b>          |
| 3254         | GHS12 (No4) | 12   | 0.85 | 15   | 9 - 32                         | Beyaz | 10                  | 400                | <b>14,30</b>          |
| 3255         | GHS15 (No5) | 15   | 1.00 | 15.5 | 12 - 35                        | Beyaz | 10                  | 250                | <b>23,00</b>          |

### Malzeme : PE

Esnek yapısı sayesinde kabloların düzenlemesine yardımcı olur.  
Güçlü yapısı sayesinde tekrar kullanım için uygundur.

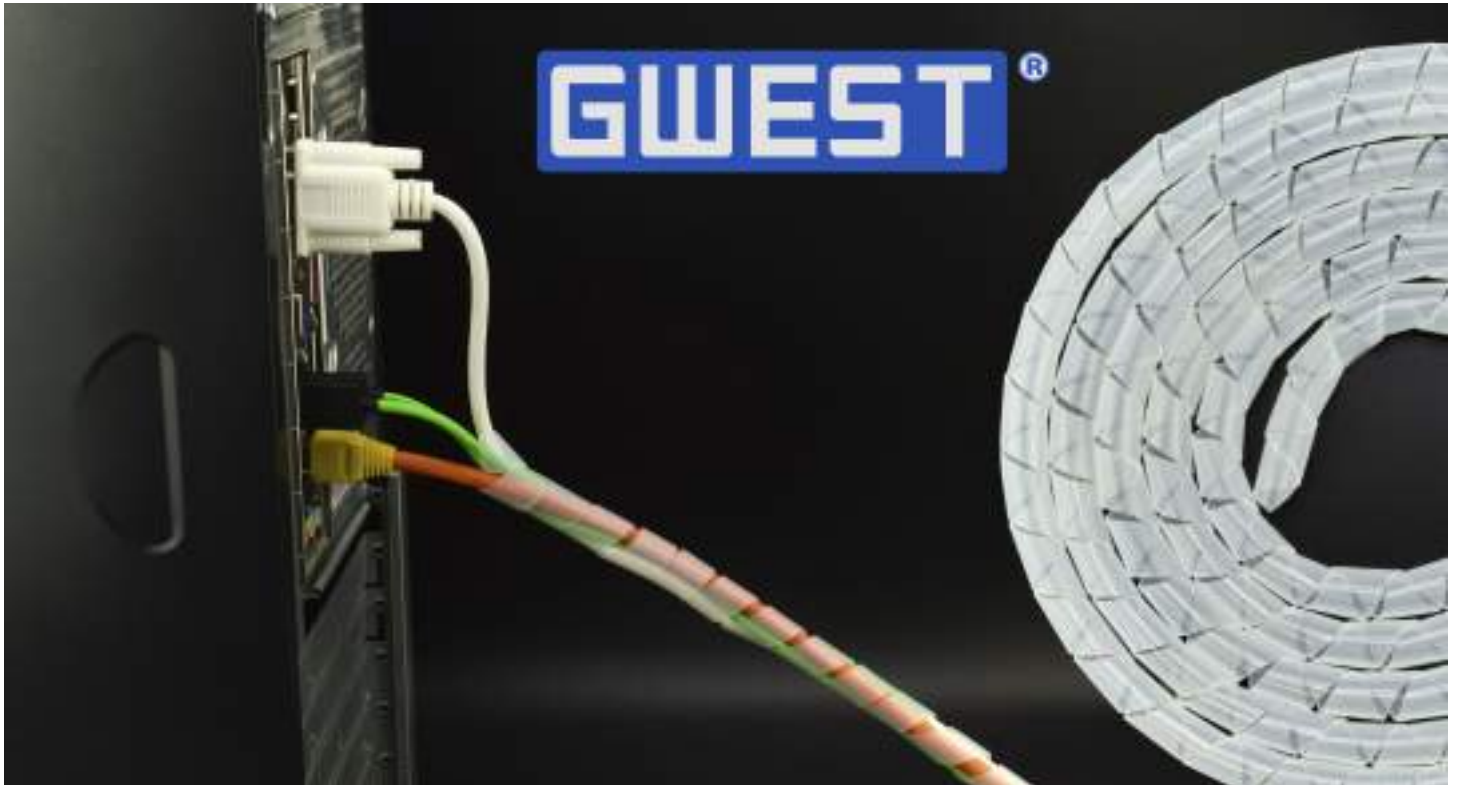
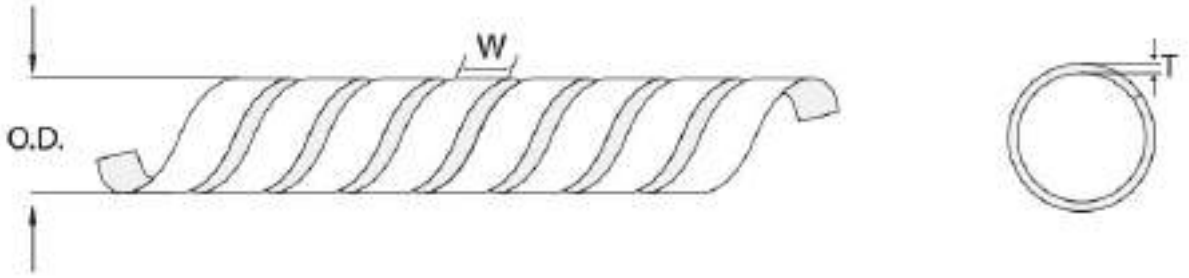





# KABLO YÜKSÜKLERİ

## Tek ve Çift Girişli



# İZOLELİ KABLO YÜKSÜKLERİ FRANSIZ NORMU



Standart : DIN 46228  
 Malzeme : Bakır, Kalay Kaplı  
 İzolasyon : Naylon  
 Çalışma Sıcaklığı : Maksimum 105° 600Volt Arası

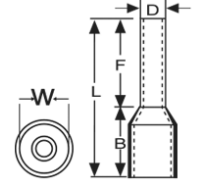

| Sipariş Kodu | Ürün Kodu  | Renk    | Kablo Kesit (mm <sup>2</sup> ) | Ebatlar (mm) |      |      |      |      | Kutu Adet | Birim Fiyat TL / Adet |
|--------------|------------|---------|--------------------------------|--------------|------|------|------|------|-----------|-----------------------|
|              |            |         |                                | F            | L    | W    | B    | D    |           |                       |
| 2001         | IYF - 0.25 | Menekşe | 0.25 mm <sup>2</sup>           | 8.0          | 12.0 | 1.9  | 4.4  | 1.1  | 1.000     | <b>0,75</b>           |
| 2002         | IYF - 0.34 | Pembe   | 0.34 mm <sup>2</sup>           | 8.0          | 12.0 | 1.9  | 4.4  | 1.1  | 1.000     | <b>0,75</b>           |
| 2003         | IYF - 0.50 | Beyaz   | 0.50 mm <sup>2</sup>           | 8.0          | 14.0 | 2.6  | 6.0  | 1.3  | 1.000     | <b>0,34</b>           |
| 2004         | IYF - 0.75 | Mavi    | 0.75 mm <sup>2</sup>           | 8.0          | 14.0 | 2.8  | 6.3  | 1.5  | 1.000     | <b>0,34</b>           |
| 2005         | IYF - 1.0  | Kırmızı | 1.00 mm <sup>2</sup>           | 8.0          | 14.0 | 3.0  | 6.3  | 1.7  | 1.000     | <b>0,34</b>           |
| 2006         | IYF - 1.5  | Siyah   | 1.50 mm <sup>2</sup>           | 8.0          | 14.0 | 3.5  | 6.3  | 2.0  | 1.000     | <b>0,38</b>           |
| 2007         | IYF - 2.5  | Gri     | 2.50 mm <sup>2</sup>           | 8.0          | 14.0 | 4.2  | 7.4  | 2.5  | 500       | <b>0,48</b>           |
| 2008         | IYF - 4.0  | Turuncu | 4.00 mm <sup>2</sup>           | 10.0         | 17.0 | 4.8  | 7.4  | 3.2  | 500       | <b>0,80</b>           |
| 2009         | IYF - 6.0  | Yeşil   | 6.00 mm <sup>2</sup>           | 12.0         | 20.0 | 6.3  | 8.5  | 3.9  | 250       | <b>1,10</b>           |
| 2010         | IYF - 10.0 | Kahve   | 10.0 mm <sup>2</sup>           | 12.0         | 22.0 | 7.6  | 8.8  | 4.9  | 100       | <b>1,37</b>           |
| 2011         | IYF - 16.0 | Bej     | 16.0 mm <sup>2</sup>           | 12.0         | 24.0 | 8.8  | 10.0 | 6.2  | 100       | <b>1,90</b>           |
| 2012         | IYF - 25.0 | Siyah   | 25.0 mm <sup>2</sup>           | 16.0         | 28.0 | 11.2 | 12.0 | 7.7  | 50        | <b>3,20</b>           |
| 2013         | IYF - 35.0 | Kırmızı | 35.0 mm <sup>2</sup>           | 16.0         | 30.0 | 12.7 | 14.0 | 8.7  | 50        | <b>4,00</b>           |
| 2014         | IYF - 50.0 | Mavi    | 50.0 mm <sup>2</sup>           | 20.0         | 36.0 | 15.0 | 16.0 | 10.9 | 25        | <b>7,50</b>           |
| 2015         | IYF - 70.0 | Sarı    | 70.0 mm <sup>2</sup>           | 21.0         | 37.0 | 16.0 | 17.0 | 14.3 | 25        | <b>14,00</b>          |



## İZOLELİ KABLO YÜKSÜKLERİ ALMAN NORMU



Standart : DIN 46228  
 Malzeme : Bakır, Kalay Kaplı  
 İzolasyon : Naylon  
 Çalışma Sıcaklığı : Maksimum 105° 600Volt Arası

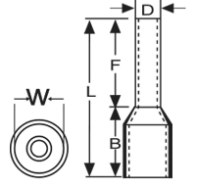

| Sipariş Kodu | Ürün Kodu  | Renk    | Kablo Kesit (mm <sup>2</sup> ) | Ebatlar (mm) |      |      |      |      | Kutu Adet | Birim Fiyat TL / Adet |
|--------------|------------|---------|--------------------------------|--------------|------|------|------|------|-----------|-----------------------|
|              |            |         |                                | F            | L    | W    | B    | D    |           |                       |
| 2101         | IYA - 0.14 | Gri     | 0.14 mm <sup>2</sup>           | 8.0          | 12.0 | 1.6  | 2.8  | 0.9  | 1.000     | <b>0,75</b>           |
| 2102         | IYA - 0.25 | Mavi    | 0.25 mm <sup>2</sup>           | 8.0          | 12.0 | 1.9  | 4.4  | 1.1  | 1.000     | <b>0,75</b>           |
| 2103         | IYA - 0.34 | Turkuaz | 0.34 mm <sup>2</sup>           | 8.0          | 12.0 | 1.9  | 4.4  | 1.1  | 1.000     | <b>0,75</b>           |
| 2104         | IYA - 0.50 | Turuncu | 0.50 mm <sup>2</sup>           | 8.0          | 14.0 | 2.6  | 6.0  | 1.3  | 1.000     | <b>0,34</b>           |
| 2105         | IYA - 0.75 | Beyaz   | 0.75 mm <sup>2</sup>           | 8.0          | 14.0 | 2.8  | 6.3  | 1.5  | 1.000     | <b>0,34</b>           |
| 2106         | IYA - 1.0  | Sarı    | 1.00 mm <sup>2</sup>           | 8.0          | 14.0 | 3.0  | 6.3  | 1.7  | 1.000     | <b>0,34</b>           |
| 2107         | IYA - 1.5  | Kırmızı | 1.50 mm <sup>2</sup>           | 8.0          | 14.0 | 3.5  | 6.3  | 2.0  | 1.000     | <b>0,38</b>           |
| 2108         | IYA - 2.5  | Mavi    | 2.50 mm <sup>2</sup>           | 8.0          | 14.0 | 4.2  | 7.4  | 2.5  | 500       | <b>0,48</b>           |
| 2109         | IYA - 4.0  | Gri     | 4.00 mm <sup>2</sup>           | 10.0         | 17.0 | 4.8  | 7.4  | 3.2  | 500       | <b>0,80</b>           |
| 2110         | IYA - 6.0  | Siyah   | 6.00 mm <sup>2</sup>           | 12.0         | 20.0 | 6.3  | 8.5  | 3.9  | 250       | <b>1,10</b>           |
| 2111         | IYA - 10.0 | Bej     | 10.0 mm <sup>2</sup>           | 12.0         | 22.0 | 7.6  | 8.8  | 4.9  | 100       | <b>1,37</b>           |
| 2112         | IYA - 16.0 | Yeşil   | 16.0 mm <sup>2</sup>           | 12.0         | 24.0 | 8.8  | 10.0 | 6.2  | 100       | <b>1,90</b>           |
| 2113         | IYA - 25.0 | Kahve   | 25.0 mm <sup>2</sup>           | 16.0         | 28.0 | 11.2 | 12.0 | 7.7  | 50        | <b>3,20</b>           |
| 2114         | IYA - 35.0 | Bej     | 35.0 mm <sup>2</sup>           | 16.0         | 30.0 | 12.7 | 14.0 | 8.7  | 50        | <b>4,00</b>           |
| 2115         | IYA - 50.0 | Yeşil   | 50.0 mm <sup>2</sup>           | 20.0         | 36.0 | 15.0 | 16.0 | 10.9 | 25        | <b>7,50</b>           |





# ÇİFT GİRİŞLİ KABLO YÜKSÜKLERİ FRANSIZ NORMU



Standart : DIN 46228  
 Malzeme : Bakır, Kalay Kaplı  
 İzolasyon : Naylon  
 Çalışma Sıcaklığı : Maksimum 105° 600Volt Arası

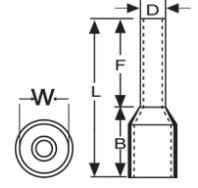

| Sipariş Kodu | Ürün Kodu  | Renk    | Kablo Kesit (mm <sup>2</sup> ) | Ebatlar (mm) |      |      |      |     | Kutu Adet | Birim Fiyat TL / Adet |
|--------------|------------|---------|--------------------------------|--------------|------|------|------|-----|-----------|-----------------------|
|              |            |         |                                | F            | L    | W    | B    | D   |           |                       |
| 2201         | CYF - 0.50 | Beyaz   | 0.50 mm <sup>2</sup>           | 8.0          | 14.0 | 5.0  | 6.5  | 1.8 | 1.000     | <b>0,60</b>           |
| 2202         | CYF - 0.75 | Mavi    | 0.75 mm <sup>2</sup>           | 8.0          | 14.0 | 5.5  | 6.7  | 2.1 | 500       | <b>0,64</b>           |
| 2203         | CYF - 1.0  | Kırmızı | 1.00 mm <sup>2</sup>           | 8.0          | 14.0 | 5.5  | 7.1  | 2.4 | 500       | <b>0,68</b>           |
| 2204         | CYF - 1.5  | Siyah   | 1.50 mm <sup>2</sup>           | 8.0          | 14.0 | 6.4  | 7.5  | 2.6 | 500       | <b>0,82</b>           |
| 2205         | CYF - 2.5  | Gri     | 2.50 mm <sup>2</sup>           | 10.0         | 14.0 | 8.0  | 8.5  | 3.3 | 250       | <b>1,33</b>           |
| 2206         | CYF - 4.0  | Turuncu | 4.00 mm <sup>2</sup>           | 12.0         | 17.0 | 8.0  | 11.1 | 4.2 | 200       | <b>1,55</b>           |
| 2207         | CYF - 6.0  | Yeşil   | 6.00 mm <sup>2</sup>           | 14.0         | 20.0 | 9.5  | 12.1 | 5.3 | 100       | <b>1,95</b>           |
| 2208         | CYF - 10.0 | Kahve   | 10.0 mm <sup>2</sup>           | 14.0         | 27.0 | 12.6 | 12.6 | 6.9 | 50        | <b>2,95</b>           |
| 2209         | CYF - 16.0 | Bej     | 16.0 mm <sup>2</sup>           | 14.0         | 31.0 | 19.0 | 17.3 | 8.7 | 50        | <b>3,70</b>           |



# ÇİFT GİRİŞLİ KABLO YÜKSÜKLERİ ALMAN NORMU



Standart : DIN 46228  
 Malzeme : Bakır, Kalay Kaplı  
 İzolasyon : Naylon  
 Çalışma Sıcaklığı : Maksimum 105° 600Volt Arası

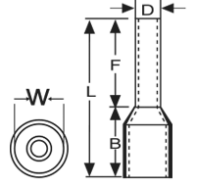

| Sipariş Kodu | Ürün Kodu  | Renk    | Kablo Kesit (mm <sup>2</sup> ) | Ebatlar (mm) |      |      |      |     | Kutu Adet | Birim Fiyat TL / Adet |
|--------------|------------|---------|--------------------------------|--------------|------|------|------|-----|-----------|-----------------------|
|              |            |         |                                | F            | L    | W    | B    | D   |           |                       |
| 2301         | CYA - 0.50 | Turuncu | 0.50 mm <sup>2</sup>           | 8.0          | 14.0 | 5.0  | 6.5  | 1.8 | 1000      | <b>0,60</b>           |
| 2302         | CYA - 0.75 | Beyaz   | 0.75 mm <sup>2</sup>           | 8.0          | 14.0 | 5.5  | 6.7  | 2.1 | 500       | <b>0,64</b>           |
| 2303         | CYA - 1.0  | Sarı    | 1.00 mm <sup>2</sup>           | 8.0          | 14.0 | 5.5  | 7.1  | 2.4 | 500       | <b>0,68</b>           |
| 2304         | CYA - 1.5  | Kırmızı | 1.50 mm <sup>2</sup>           | 8.0          | 14.0 | 6.4  | 7.5  | 2.6 | 500       | <b>0,82</b>           |
| 2305         | CYA - 2.5  | Mavi    | 2.50 mm <sup>2</sup>           | 10.0         | 14.0 | 8.0  | 8.5  | 3.3 | 250       | <b>1,33</b>           |
| 2306         | CYA - 4.0  | Gri     | 4.00 mm <sup>2</sup>           | 12.0         | 17.0 | 8.0  | 11.1 | 4.2 | 200       | <b>1,55</b>           |
| 2307         | CYA - 6.0  | Siyah   | 6.00 mm <sup>2</sup>           | 14.0         | 20.0 | 9.5  | 12.1 | 5.3 | 100       | <b>1,95</b>           |
| 2308         | CYA - 10.0 | Bej     | 10.0 mm <sup>2</sup>           | 14.0         | 27.0 | 12.6 | 12.6 | 6.9 | 50        | <b>2,95</b>           |
| 2309         | CYA - 16.0 | Yeşil   | 16.0 mm <sup>2</sup>           | 14.0         | 31.0 | 19.0 | 17.3 | 8.7 | 50        | <b>3,70</b>           |





## İZOLESİZ KABLO YÜKSÜKLERİ



Standart : DIN 46228  
Malzeme : Bakır, Kalay Kaplı  
İzolasyon : Yok

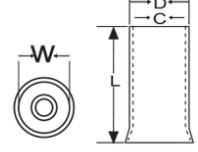

| Sipariş Kodu | Ürün Kodu | Kablo Kesit (mm <sup>2</sup> ) | Ebatlar (mm) |     |     |     | Kutu Adet | Birim Fiyat TL / Adet |
|--------------|-----------|--------------------------------|--------------|-----|-----|-----|-----------|-----------------------|
|              |           |                                | L            | W   | D   | C   |           |                       |
| 2401         | KY - 0.50 | 0.50 mm <sup>2</sup>           | 10           | 2.1 | 1.3 | 1.0 | 2.000     | <b>0,34</b>           |
| 2402         | KY - 0.75 | 0.75 mm <sup>2</sup>           | 10           | 2.3 | 1.5 | 1.2 | 1.000     | <b>0,34</b>           |
| 2403         | KY - 1.0  | 1.00 mm <sup>2</sup>           | 10           | 2.5 | 1.7 | 1.4 | 1.000     | <b>0,34</b>           |
| 2404         | KY - 1.5  | 1.50 mm <sup>2</sup>           | 10           | 2.8 | 2.0 | 1.7 | 1.000     | <b>0,38</b>           |
| 2405         | KY - 2.5  | 2.50 mm <sup>2</sup>           | 12           | 3.4 | 2.5 | 2.2 | 1.000     | <b>0,53</b>           |
| 2406         | KY - 4.0  | 4.00 mm <sup>2</sup>           | 12           | 4.0 | 3.2 | 2.8 | 1.000     | <b>0,70</b>           |
| 2407         | KY - 6.0  | 6.00 mm <sup>2</sup>           | 12           | 4.7 | 3.9 | 3.5 | 500       | <b>0,95</b>           |
| 2408         | KY - 10.0 | 10.0 mm <sup>2</sup>           | 15           | 5.8 | 4.9 | 4.5 | 250       | <b>1,60</b>           |
| 2409         | KY - 16.0 | 16.0 mm <sup>2</sup>           | 15           | 7.5 | 6.2 | 5.8 | 250       | <b>2,00</b>           |





# KABLO UÇLARI

## Ve Terminaller



# YUVARLAK TİP İZOLELİ KABLO UÇLARI



Standart : DIN 46237  
 Malzeme : Bakır, Kalay Kaplı  
 İzolasyon : PVC  
 Çalışma Sıcaklığı : Maksimum 105° 600Volt Arası

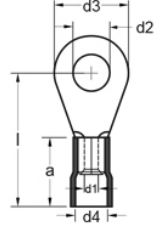

| Sipariş Kodu | Ürün Kodu  | Renk      | Kablo Kesit (mm <sup>2</sup> ) | Civata Ölçüsü               | Ebatlar (mm) |      |      |      |     |      | Kutu Adet | Birim Fiyat TL / Adet |
|--------------|------------|-----------|--------------------------------|-----------------------------|--------------|------|------|------|-----|------|-----------|-----------------------|
|              |            |           |                                |                             | d2           | d3   | l    | d1   | d4  | a    |           |                       |
| 3001         | GYU - 301  | ■ Kırmızı | 0.50 - 1.50 mm <sup>2</sup>    | M3                          | 3.2          | 6.0  | 16.0 | 1.6  | 4.0 | 10.0 | 200       | <b>1,10</b>           |
| 3003         | GYU - 401  | ■ Kırmızı |                                | M4                          | 4.3          | 8.0  | 17.0 | 1.6  | 4.0 | 10.0 | 200       | <b>1,63</b>           |
| 3004         | GYU - 501  | ■ Kırmızı |                                | M5                          | 5.3          | 10.0 | 18.0 | 1.6  | 4.0 | 10.0 | 200       | <b>1,65</b>           |
| 3005         | GYU - 601  | ■ Kırmızı |                                | M6                          | 6.5          | 10.0 | 18.0 | 1.6  | 4.0 | 10.0 | 200       | <b>2,60</b>           |
| 3006         | GYU - 801  | ■ Kırmızı |                                | M8                          | 8.4          | 14.0 | 22.0 | 1.6  | 4.0 | 10.0 | 200       | <b>2,60</b>           |
| 3007         | GYU - 302  | ■ Mavi    |                                | 1.50 - 2.50 mm <sup>2</sup> | M3           | 3.2  | 6.0  | 16.0 | 2.3 | 4.5  | 10.0      | 200                   |
| 3008         | GYU - 402  | ■ Mavi    | M4                             |                             | 4.3          | 8.0  | 17.0 | 2.3  | 4.5 | 10.0 | 200       | <b>2,00</b>           |
| 3009         | GYU - 502  | ■ Mavi    | M5                             |                             | 5.3          | 10.0 | 19.0 | 2.3  | 4.5 | 10.0 | 200       | <b>2,05</b>           |
| 3010         | GYU - 602  | ■ Mavi    | M6                             |                             | 6.5          | 11.0 | 20.0 | 2.3  | 4.5 | 10.0 | 200       | <b>2,90</b>           |
| 3011         | GYU - 802  | ■ Mavi    | M8                             |                             | 8.4          | 14.0 | 22.0 | 2.3  | 4.5 | 10.0 | 200       | <b>2,90</b>           |
| 3012         | GYU - 1002 | ■ Mavi    | M10                            |                             | 10.5         | 15.0 | 22.0 | 2.3  | 4.5 | 10.0 | 200       | <b>3,00</b>           |
| 3013         | GYU - 406  | ■ Sarı    | 4.00 - 6.00 mm <sup>2</sup>    | M4                          | 4.3          | 8.6  | 21.0 | 3.6  | 6.3 | 13.0 | 100       | <b>4,25</b>           |
| 3014         | GYU - 506  | ■ Sarı    |                                | M5                          | 5.3          | 10.0 | 22.0 | 3.6  | 6.3 | 13.0 | 100       | <b>4,25</b>           |
| 3015         | GYU - 606  | ■ Sarı    |                                | M6                          | 6.5          | 11.0 | 22.5 | 3.6  | 6.3 | 13.0 | 100       | <b>4,80</b>           |
| 3016         | GYU - 806  | ■ Sarı    |                                | M8                          | 8.4          | 14.0 | 26.0 | 3.6  | 6.3 | 13.0 | 100       | <b>6,20</b>           |
| 3017         | GYU - 1006 | ■ Sarı    |                                | M10                         | 10.5         | 18.0 | 28.0 | 3.6  | 6.3 | 13.0 | 100       | <b>6,30</b>           |
| 3018         | GYU - 1206 | ■ Sarı    |                                | M12                         | 13.0         | 18.0 | 28.0 | 3.6  | 6.3 | 13.0 | 100       | <b>6,40</b>           |
| 3019         | GYU - 610  | ■ Kırmızı | 8.00 - 10.00 mm <sup>2</sup>   | M6                          | 6.7          | 23.5 | 30.0 | 4.5  | 8.0 | 17.0 | 50        | <b>7,00</b>           |
| 3020         | GYU - 810  | ■ Kırmızı |                                | M8                          | 8.4          | 26.3 | 36.0 | 4.5  | 8.0 | 17.0 | 50        | <b>8,50</b>           |

## ÇATAL TİP İZOLELİ KABLO UÇLARI



Standart : DIN 46237  
 Malzeme : Bakır, Kalay Kaplı  
 İzolasyon : PVC  
 Çalışma Sıcaklığı : Maksimum 105° 600Volt Arası

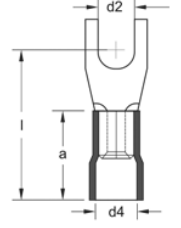

| Sipariş Kodu | Ürün Kodu  | Renk    | Kablo Kesit (mm <sup>2</sup> ) | Civata Ölçüsü | Ebatlar (mm) |      |      |     |     |      | Kutu Adet | Birim Fiyat TL / Adet |
|--------------|------------|---------|--------------------------------|---------------|--------------|------|------|-----|-----|------|-----------|-----------------------|
|              |            |         |                                |               | d2           | d3   | l    | d1  | d4  | a    |           |                       |
| 3101         | GÇU - 3001 | Kırmızı | 0.50 - 1.50 mm <sup>2</sup>    | M3            | 3.2          | 6.0  | 16.0 | 1.6 | 4.0 | 10.0 | 200       | 1,50                  |
| 3102         | GÇU - 4001 | Kırmızı |                                | M4            | 4.3          | 8.0  | 17.0 | 1.6 | 4.0 | 10.0 | 200       | 1,53                  |
| 3103         | GÇU - 5001 | Kırmızı |                                | M5            | 5.3          | 10.0 | 18.0 | 1.6 | 4.0 | 10.0 | 200       | 1,60                  |
| 3104         | GÇU - 6001 | Kırmızı |                                | M6            | 6.5          | 11.0 | 20.0 | 1.6 | 4.0 | 10.0 | 200       | 1,80                  |
| 3105         | GÇU - 3002 | Mavi    | 1.50 - 2.50 mm <sup>2</sup>    | M3            | 3.2          | 5.5  | 18.0 | 2.3 | 4.5 | 10.0 | 200       | 1,65                  |
| 3106         | GÇU - 4002 | Mavi    |                                | M4            | 4.3          | 6.8  | 17.0 | 2.3 | 4.5 | 10.0 | 200       | 1,70                  |
| 3107         | GÇU - 5002 | Mavi    |                                | M5            | 5.3          | 10.0 | 19.0 | 2.3 | 4.5 | 10.0 | 200       | 1,75                  |
| 3108         | GÇU - 6002 | Mavi    |                                | M6            | 6.5          | 11.0 | 21.0 | 2.3 | 4.5 | 10.0 | 200       | 2,30                  |
| 3109         | GÇU - 4006 | Sarı    | 4.00 - 6.00 mm <sup>2</sup>    | M4            | 4.3          | 8.0  | 21.0 | 3.6 | 6.3 | 13.0 | 100       | 3,70                  |
| 3110         | GÇU - 5006 | Sarı    |                                | M5            | 5.3          | 10.0 | 22.0 | 3.6 | 6.3 | 13.0 | 100       | 3,75                  |
| 3111         | GÇU - 6006 | Sarı    |                                | M6            | 6.5          | 11.0 | 23.0 | 3.6 | 6.3 | 13.0 | 100       | 5,00                  |
| 3112         | GÇU - 8006 | Sarı    |                                | M8            | 8.4          | 14.0 | 26.0 | 3.6 | 6.3 | 13.0 | 100       | 5,90                  |

## EK MUFLARI İZOLELİ KABLO UÇLARI



Standart : DIN 46237  
 Malzeme : Bakır, Kalay Kaplı  
 İzolasyon : PVC  
 Çalışma Sıcaklığı : Maksimum 75° 600Volt Arası

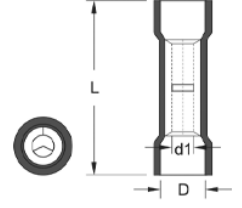

| Sipariş Kodu | Ürün Kodu | Renk    | Kablo Kesit (mm <sup>2</sup> ) | Ebatlar (mm) |     |     | Kutu Adet | Birim Fiyat TL / Adet |
|--------------|-----------|---------|--------------------------------|--------------|-----|-----|-----------|-----------------------|
|              |           |         |                                | L            | D   | d1  |           |                       |
| 3201         | GBY - 251 | Kırmızı | 0.50 - 1.50 mm <sup>2</sup>    | 24.6         | 4.0 | 1.7 | 200       | <b>2,30</b>           |
| 3202         | GBY - 252 | Mavi    | 1.50 - 2.50 mm <sup>2</sup>    | 24.6         | 4.5 | 2.3 | 200       | <b>2,30</b>           |
| 3203         | GBY - 256 | Sarı    | 4.00 - 6.00 mm <sup>2</sup>    | 26.5         | 6.3 | 3.4 | 100       | <b>3,90</b>           |

## ERKEK TERMİNALLER İZOLELİ KABLO UÇLARI



Malzeme : Pirinç, Kalay Kaplı, Bakır Yüksüklü  
 İzolasyon : PVC  
 Çalışma Sıcaklığı : Maksimum 75° 600Volt Arası

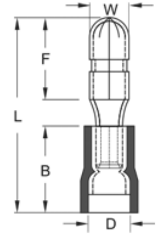

| Sipariş Kodu | Ürün Kodu  | Renk    | Kablo Kesit (mm <sup>2</sup> ) | Ebatlar (mm) |     |      |      |     | Kutu Adet | Birim Fiyat TL / Adet |
|--------------|------------|---------|--------------------------------|--------------|-----|------|------|-----|-----------|-----------------------|
|              |            |         |                                | W            | F   | L    | B    | D   |           |                       |
| 3204         | GBE - 1040 | Kırmızı | 0.50 - 1.50 mm <sup>2</sup>    | 4.0          | 8.5 | 21.5 | 10.5 | 3.8 | 200       | <b>3,80</b>           |
| 3205         | GBE - 2050 | Mavi    | 1.50 - 2.50 mm <sup>2</sup>    | 5.0          | 8.5 | 21.2 | 10.5 | 4.7 | 200       | <b>4,40</b>           |
| 3206         | GBE - 5050 | Sarı    | 4.00 - 6.00 mm <sup>2</sup>    | 5.0          | 8.5 | 24.0 | 13.0 | 6.2 | 200       | <b>5,80</b>           |

## DİŞİ TERMİNALLER İZOLELİ KABLO UÇLARI



Malzeme : Pirinç, Kalay Kaplı, Bakır Yüksüklü  
 İzolasyon : PVC  
 Çalışma Sıcaklığı : Maksimum 75° 600Volt Arası

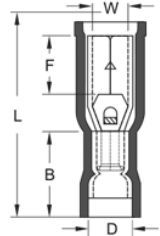

| Sipariş Kodu | Ürün Kodu  | Renk    | Kablo Kesit (mm <sup>2</sup> ) | Ebatlar (mm) |     |      |      |     | Kutu Adet | Birim Fiyat TL / Adet |
|--------------|------------|---------|--------------------------------|--------------|-----|------|------|-----|-----------|-----------------------|
|              |            |         |                                | W            | F   | L    | B    | D   |           |                       |
| 3207         | GBD - 1040 | Kırmızı | 0.50 - 1.50 mm <sup>2</sup>    | 3.9          | 7.0 | 23.3 | 10.5 | 3.8 | 200       | <b>4,60</b>           |
| 3208         | GBD - 2050 | Mavi    | 1.50 - 2.50 mm <sup>2</sup>    | 4.9          | 7.0 | 23.3 | 10.5 | 4.7 | 100       | <b>5,20</b>           |
| 3209         | GBD - 5050 | Sarı    | 4.00 - 6.00 mm <sup>2</sup>    | 4.9          | 7.0 | 25.1 | 12.5 | 6.2 | 100       | <b>6,50</b>           |



## DİŞİ FASTON TİP İZOLELİ KABLO UÇLARI



Malzeme : Pirinç, Kalay Kaplı  
İzolasyon : PVC  
Çalışma Sıcaklığı : Maksimum 75° 600Volt Arası

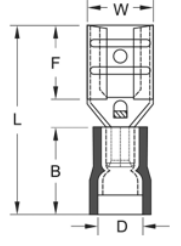

| Sipariş Kodu | Ürün Kodu  | Renk    | Kablo Kesit (mm <sup>2</sup> ) | Soket Genişliği | Ebatlar (mm) |     |      |      |     | Kutu Adet | Birim Fiyat TL / Adet |
|--------------|------------|---------|--------------------------------|-----------------|--------------|-----|------|------|-----|-----------|-----------------------|
|              |            |         |                                |                 | W            | F   | L    | B    | D   |           |                       |
| 3210         | GFD - 1288 | Kırmızı | 0.50 - 1.50 mm <sup>2</sup>    | 0.8 x 2.80      | 3.2          | 6.5 | 19.0 | 10.5 | 3.8 | 200       | 1,00                  |
| 3211         | GFD - 1488 | Kırmızı |                                | 0.8 x 4.75      | 5.0          | 6.4 | 19.4 | 10.5 | 3.8 | 200       | 1,32                  |
| 3212         | GFD - 1638 | Kırmızı |                                | 0.8 x 6.35      | 6.6          | 7.5 | 20.8 | 10.5 | 3.8 | 200       | 1,70                  |
| 3213         | GFD - 2288 | Mavi    | 1.50 - 2.50 mm <sup>2</sup>    | 0.8 x 2.80      | 3.2          | 6.5 | 19.0 | 10.5 | 4.7 | 200       | 1,32                  |
| 3214         | GFD - 2488 | Mavi    |                                | 0.8 x 4.75      | 5.0          | 6.4 | 19.4 | 10.5 | 4.7 | 200       | 1,38                  |
| 3215         | GFD - 2638 | Mavi    |                                | 0.8 x 6.35      | 6.6          | 7.5 | 20.8 | 10.5 | 4.7 | 200       | 1,72                  |
| 3216         | GFD - 5638 | Sarı    | 4.00 - 6.00 mm <sup>2</sup>    | 0.8 x 6.35      | 6.6          | 7.5 | 23.3 | 13.0 | 6.2 | 200       | 1,95                  |

## TAM İZOLELİ DİŞİ FASTON TİP KABLO UÇLARI



Malzeme : Pirinç, Kalay Kaplı  
İzolasyon : PVC  
Çalışma Sıcaklığı : Maksimum 75° 600Volt Arası

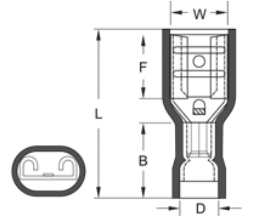

| Sipariş Kodu | Ürün Kodu   | Renk    | Kablo Kesit (mm <sup>2</sup> ) | Soket Genişliği | Ebatlar (mm) |     |      |      |     | Kutu Adet | Birim Fiyat TL / Adet |
|--------------|-------------|---------|--------------------------------|-----------------|--------------|-----|------|------|-----|-----------|-----------------------|
|              |             |         |                                |                 | W            | F   | L    | B    | D   |           |                       |
| 3218         | GFFD - 1288 | Kırmızı | 0.50 - 1.50 mm <sup>2</sup>    | 0.8 x 2.80      | 3.2          | 6.5 | 19.0 | 10.5 | 3.8 | 200       | 1,65                  |
| 3219         | GFFD - 1488 | Kırmızı |                                | 0.8 x 4.75      | 5.0          | 6.4 | 20.5 | 10.5 | 3.8 | 200       | 1,95                  |
| 3220         | GFFD - 1638 | Kırmızı |                                | 0.8 x 6.35      | 6.6          | 7.5 | 21.8 | 10.5 | 3.8 | 200       | 2,30                  |
| 3221         | GFFD - 2288 | Mavi    | 1.50 - 2.50 mm <sup>2</sup>    | 0.8 x 2.80      | 3.2          | 6.5 | 20.0 | 10.5 | 4.7 | 200       | 1,95                  |
| 3222         | GFFD - 2488 | Mavi    |                                | 0.8 x 4.75      | 5.0          | 6.4 | 20.2 | 10.5 | 4.7 | 200       | 2,00                  |
| 3223         | GFFD - 2638 | Mavi    |                                | 0.8 x 6.35      | 6.6          | 7.5 | 22.2 | 10.5 | 4.7 | 200       | 2,40                  |
| 3224         | GFFD - 5638 | Sarı    | 4.00 - 6.00 mm <sup>2</sup>    | 0.8 x 6.35      | 6.6          | 7.5 | 24.2 | 12.5 | 6.2 | 100       | 2,80                  |



## TAM İZOLELİ POLYAMİD DİŞİ FASTON TİP KABLO UÇLARI



Malzeme : Pirinç, Kalay Kaplı  
İzolasyon : Polyamid  
Çalışma Sıcaklığı : Maksimum 105° 600Volt Arası

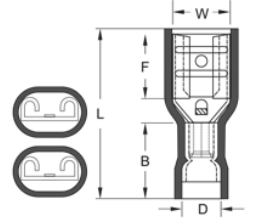

| Sipariş Kodu | Ürün Kodu   | Renk      | Kablo Kesit (mm <sup>2</sup> ) | Soket Genişliği | Ebatlar (mm) |     |      |      |     | Kutu Adet | Birim Fiyat TL / Adet |
|--------------|-------------|-----------|--------------------------------|-----------------|--------------|-----|------|------|-----|-----------|-----------------------|
|              |             |           |                                |                 | W            | F   | L    | B    | D   |           |                       |
| 3225         | GPFD - 1638 | ■ Kırmızı | 0.50 - 1.50 mm <sup>2</sup>    | 0.8 x 6.35      | 6.6          | 7.5 | 21.5 | 11.0 | 4.0 | 200       | <b>5,80</b>           |
| 3226         | GPFD - 2638 | ■ Mavi    | 1.50 - 2.50 mm <sup>2</sup>    | 0.8 x 6.35      | 6.6          | 7.5 | 21.5 | 11.0 | 5.0 | 200       | <b>5,80</b>           |
| 3227         | GPFD - 5638 | ■ Sarı    | 4.00 - 6.00 mm <sup>2</sup>    | 0.8 x 6.35      | 6.6          | 7.5 | 24.2 | 13.0 | 6.5 | 100       | <b>7,00</b>           |

## İĞNE TİP İZOLELİ KABLO UÇLARI



Malzeme : Pirinç, Kalay Kaplı  
İzolasyon : PVC  
Çalışma Sıcaklığı : Maksimum 75° 600Volt Arası

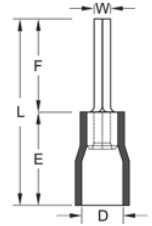

| Sipariş Kodu | Ürün Kodu | Renk      | Kablo Kesit (mm <sup>2</sup> ) | Ebatlar (mm) |      |      |      |     | Kutu Adet | Birim Fiyat TL / Adet |
|--------------|-----------|-----------|--------------------------------|--------------|------|------|------|-----|-----------|-----------------------|
|              |           |           |                                | W            | F    | L    | E    | D   |           |                       |
| 3228         | GİK - 101 | ■ Kırmızı | 0.50 - 1.50 mm <sup>2</sup>    | 1.9          | 10.0 | 19.0 | 10.0 | 4.0 | 200       | <b>1,75</b>           |
| 3229         | GİK - 102 | ■ Mavi    | 1.50 - 2.50 mm <sup>2</sup>    | 1.9          | 12.0 | 21.8 | 10.0 | 4.5 | 200       | <b>2,10</b>           |
| 3230         | GİK - 106 | ■ Sarı    | 4.00 - 6.00 mm <sup>2</sup>    | 2.8          | 14.0 | 27.0 | 27.0 | 6.4 | 100       | <b>5,00</b>           |

## ERKEK / DİŞİ GERİ DÖNÜŞLÜ TERMİNALLER



Malzeme : Pirinç, Kalay Kaplı  
İzolasyon : PVC  
Çalışma Sıcaklığı : Maksimum 75° 600Volt Arası

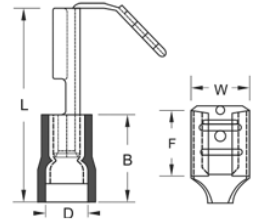

| Sipariş Kodu | Ürün Kodu    | Renk      | Kablo Kesit (mm <sup>2</sup> ) | Soket Genişliği | Ebatlar (mm) |     |      |      |     | Kutu Adet | Birim Fiyat TL / Adet |
|--------------|--------------|-----------|--------------------------------|-----------------|--------------|-----|------|------|-----|-----------|-----------------------|
|              |              |           |                                |                 | W            | F   | L    | B    | D   |           |                       |
| 3231         | GFDEG - 1861 | ■ Kırmızı | 0.50 - 1.50 mm <sup>2</sup>    | 0.8 x 6.35      | 6.6          | 8.0 | 22.5 | 10.5 | 3.8 | 100       | <b>3,20</b>           |
| 3232         | GFDEG - 2862 | ■ Mavi    | 1.50 - 2.50 mm <sup>2</sup>    | 0.8 x 6.35      | 6.6          | 8.0 | 22.5 | 10.5 | 4.7 | 100       | <b>3,50</b>           |
| 3233         | GFDEG - 5866 | ■ Sarı    | 4.00 - 6.00 mm <sup>2</sup>    | 0.8 x 6.35      | 6.6          | 8.0 | 24.0 | 13.0 | 6.2 | 100       | <b>3,80</b>           |

## ERKEK FASTON TİP TERMİNALLER



Malzeme : Pirinç, Kalay Kaplı  
İzolasyon : PVC  
Çalışma Sıcaklığı : Maksimum 75° 600Volt Arası

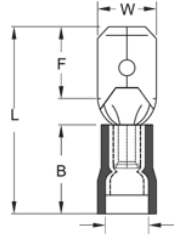

| Sipariş Kodu | Ürün Kodu  | Renk    | Kablo Kesit (mm <sup>2</sup> ) | Soket Genişliği | Ebatlar (mm) |      |      |      |     | Kutu Adet | Birim Fiyat TL / Adet |
|--------------|------------|---------|--------------------------------|-----------------|--------------|------|------|------|-----|-----------|-----------------------|
|              |            |         |                                |                 | W            | F    | L    | B    | D   |           |                       |
| 3236         | GFE - 1288 | Kırmızı | 0.50 - 1.50 mm <sup>2</sup>    | 0.8 x 2.80      | 2.8          | 6.5  | 19.2 | 10.5 | 3.8 | 200       | 1,10                  |
| 3237         | GFE - 1488 | Kırmızı |                                | 0.8 x 4.75      | 4.8          | 6.7  | 19.8 | 10.5 | 3.8 | 200       | 1,25                  |
| 3238         | GFE - 1638 | Kırmızı |                                | 0.8 x 6.35      | 6.35         | 6.35 | 21.8 | 10.5 | 3.8 | 200       | 1,60                  |
| 3239         | GFE - 2288 | Mavi    | 1.50 - 2.50 mm <sup>2</sup>    | 0.8 x 2.80      | 2.8          | 6.7  | 19.8 | 10.5 | 4.7 | 200       | 1,10                  |
| 3240         | GFE - 2488 | Mavi    |                                | 0.8 x 4.75      | 4.8          | 6.7  | 19.8 | 10.5 | 4.7 | 200       | 1,40                  |
| 3241         | GFE - 2638 | Mavi    |                                | 0.8 x 6.35      | 6.35         | 7.7  | 21.8 | 10.5 | 4.7 | 200       | 1,65                  |
| 3242         | GFE - 5638 | Sarı    | 4.00 - 6.00 mm <sup>2</sup>    | 0.8 x 6.35      | 6.35         | 7.7  | 24.8 | 13.0 | 6.2 | 200       | 1,95                  |

## TAM İZOLELİ POLYAMİD BAYRAK TİP TERMİNALLER





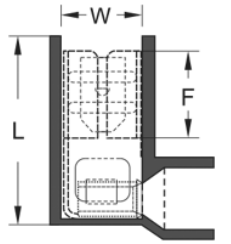

















Malzeme : Pirinç, Kalay Kaplı  
İzolasyon : Polyamid  
Çalışma Sıcaklığı : Maksimum 105° 600Volt Arası



| Sipariş Kodu | Ürün Kodu     | Renk    | Kablo Kesit (mm <sup>2</sup> ) | Soket Genişliği | Ebatlar (mm) |     |      | Kutu Adet | Birim Fiyat TL / Adet |
|--------------|---------------|---------|--------------------------------|-----------------|--------------|-----|------|-----------|-----------------------|
|              |               |         |                                |                 | W            | F   | L    |           |                       |
| 3234         | GPFDEB - 1861 | Kırmızı | 1.50 - 2.50 mm <sup>2</sup>    | 0.8 x 6.35      | 6.6          | 7.6 | 16.0 | 100       | 4,30                  |
| 3235         | GPFDEB - 2862 | Mavi    | 1.50 - 2.50 mm <sup>2</sup>    | 0.8 x 6.35      | 6.6          | 7.6 | 16.0 | 100       | 4,30                  |

## İZOLESİZ KABLO UCU VE KONNEKTÖRLERİ

|   |   |   |   |   |                               |
|---|---|---|---|---|-------------------------------|
|    |    |    |    |    |                               |
| Sipariş Kodu  | 3301  | 3302  | 3303  | 3305  | 3304                          |
| Ürün Kodu   | GF1/2D  | GFID MİNİ   | GFID  | GF3D  | GF2D TRK                      |
| Açıklama  | 2.8 Mikro Dişi Terminal   | 4.8 Mini Dişi Terminal  | 6.3 Dişi Terminal   | 9.5 Dişi Terminal   | 6.3 Tırnaklı Dişi Terminal    |
| Kutu Adet   | 1.000   | 500   | 300   | 100   | 300                           |
| Birim Fiyat TL / Adet   | <b>0,79</b>   | <b>1,10</b>   | <b>1,55</b>   | <b>3,70</b>   | <b>1,55</b>                   |
|    |    |    |    |    |                               |
| Sipariş Kodu  | 3306  | 3307  | 3320  | 3321  | 3309                          |
| Ürün Kodu   | GFID EĞRİ   | GFID E  | GKN 1-03  | GKN 1-04  | GKN 2.5-04                    |
| Açıklama  | 6.3 Eğri Dişi Terminal  | 6.3 Erkek Geri Dönüşümlü Terminal   | M3 Topraklama Terminali   | M4 Topraklama Terminali   | M4 Topraklama Terminali       |
| Kutu Adet   | 250   | 200   | 500   | 500   | 500                           |
| Birim Fiyat TL / Adet   | <b>1,80</b>   | <b>3,00</b>   | <b>1,30</b>   | <b>1,30</b>   | <b>1,30</b>                   |
|   |   |   |   |   |                               |
| Sipariş Kodu  | 3310  | 3311  | 3312  | 3313  | 3314                          |
| Ürün Kodu   | GKN 2.5-05  | GKN 2.5-06  | GKN 4-04  | GKN 4-05  | GKN 4-06                      |
| Açıklama  | M5 Topraklama Terminali   | M6 Topraklama Terminali   | M4 Topraklama Terminali   | M5 Topraklama Terminali   | M6 Topraklama Terminali       |
| Kutu Adet   | 500   | 500   | 250   | 250   | 250                           |
| Birim Fiyat TL / Adet   | <b>1,30</b>   | <b>1,30</b>   | <b>3,00</b>   | <b>3,00</b>   | <b>3,00</b>                   |
|  |  |  |  |  |                               |
| Sipariş Kodu  | 3315  | 3316  | 3318  | 3325  | 3326                          |
| Ürün Kodu   | GKN 6-06  | GKN 8-08  | GKN 10-10   | GK 2.5  | GK 4                          |
| Açıklama  | M6 Topraklama Terminali   | M8 Topraklama Terminali   | M10 Topraklama Terminali  | Boru Tip Topraklama Terminali   | Boru Tip Topraklama Terminali |
| Kutu Adet   | 150   | 150   | 100   | 1.000   | 500                           |
| Birim Fiyat TL / Adet   | <b>3,90</b>   | <b>3,90</b>   | <b>4,70</b>   | <b>1,55</b>   | <b>2,60</b>                   |
|  |  |  |  |  |                               |
| Sipariş Kodu  | 3327  | 3332  | 3333  | 3341  | 3340                          |
| Ürün Kodu   | GK 6  | GFIE ÇK   | GFIEU1  | R TİPİ KONNEKTÖR  | GFID KILIF                    |
| Açıklama  | Boru Tip Topraklama Terminali   | 6.3 Erkek Terminal  | 6.3 Uzun Erkek Terminal   | 6.3 Kilitli Konnektör   | 6.3 Terminal Kılıfı           |
| Kutu Adet   | 250   | 300   | 300   | 300   | 300                           |
| Birim Fiyat TL / Adet   | <b>2,80</b>   | <b>1,55</b>   | <b>2,10</b>   | <b>0,95</b>   | <b>0,65</b>                   |



# İMALATLARIMIZ Ve Bağlantı Elemanları

Sıkmalı Kablo Pabucu  
DIN Kablo Pabucu  
Bimetal Kablo Pabucu  
Montaj Rayları  
W Otomat Baraları  
U Klemenesler



[www.guvenelektrik.com.tr](http://www.guvenelektrik.com.tr)

## SKP EKO TİP KABLO PABUCU

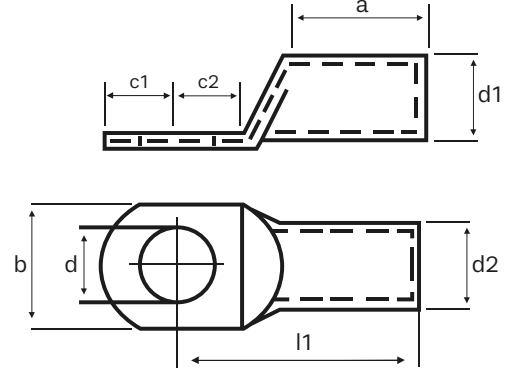
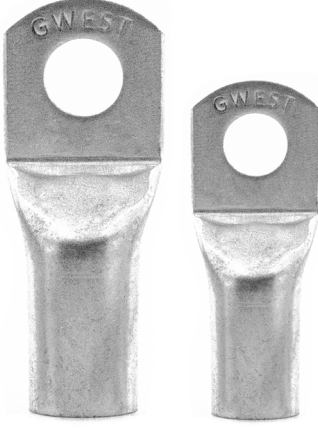

### Gwest Eko Tip Kablo Pabuçlarımız;

- EN/13600 standartlarında bakır malzemeden imal edilmiştir.
- Sıkma işlemi yapılırken kırılmayı, sıkma işlemi sonrasında gevşemeyi önlemek için üretim esnasında **tavlı bakır borular** kullanılmıştır.
- Üretimde **%99.9** oranında iletkenliğe sahip bakır kullanılmıştır.
- **5-8 Micron** aralığında **100% Kalay** kaplama yapılmaktadır.

| Sipariş Kodu | Ürün Kodu   | Kablo Kesit (mm <sup>2</sup> ) | Delik Çapı Ø | Boyutlar |      |      |      |      |      |      |      | Kutu Adet | Birim Fiyat TL / Adet |
|--------------|-------------|--------------------------------|--------------|----------|------|------|------|------|------|------|------|-----------|-----------------------|
|              |             |                                |              | d        | d1   | d2   | l1   | a    | b    | c1   | c2   |           |                       |
| 3400         | SKP-E 16-6  | 16 mm <sup>2</sup>             | M6           | 6,4      | 5,5  | 7,0  | 24,5 | 11,0 | 10,5 | 5,5  | 6,5  | 500       | 11,00                 |
| 3401         | SKP-E 16-8  |                                | M8           | 8,3      | 5,5  | 7,0  | 24,5 | 11,0 | 10,5 | 5,5  | 6,5  | 500       | 11,00                 |
| 3402         | SKP-E 25-6  | 25 mm <sup>2</sup>             | M6           | 6,5      | 7,0  | 9,0  | 31,7 | 12,0 | 13,0 | 6,8  | 9,2  | 400       | 20,00                 |
| 3403         | SKP-E 25-8  |                                | M8           | 8,3      | 7,0  | 9,0  | 31,7 | 12,0 | 13,0 | 6,8  | 9,2  | 400       | 20,00                 |
| 3404         | SKP-E 35-6  | 35 mm <sup>2</sup>             | M6           | 6,5      | 8,5  | 10,5 | 35,2 | 14,0 | 15,5 | 8,3  | 9,7  | 300       | 27,00                 |
| 3405         | SKP-E 35-8  |                                | M8           | 8,3      | 8,5  | 10,5 | 35,2 | 14,0 | 15,5 | 8,3  | 9,7  | 300       | 27,00                 |
| 3406         | SKP-E 50-8  | 50 mm <sup>2</sup>             | M8           | 8,2      | 10,0 | 12,0 | 41,5 | 17,0 | 17,9 | 10,0 | 12,0 | 200       | 38,00                 |
| 3407         | SKP-E 50-10 |                                | M10          | 10,3     | 10,0 | 12,0 | 41,5 | 17,0 | 17,9 | 10,0 | 12,0 | 200       | 38,00                 |
| 3408         | SKP-E 70-10 | 70 mm <sup>2</sup>             | M10          | 10,3     | 11,5 | 14,0 | 45,5 | 18,0 | 20,7 | 10,0 | 12,0 | 100       | 58,00                 |
| 3409         | SKP-E 70-12 |                                | M12          | 13,0     | 11,5 | 14,0 | 45,5 | 18,0 | 20,7 | 10,0 | 12,0 | 100       | 58,00                 |



## SKP EKO TİP KABLO PABUCU

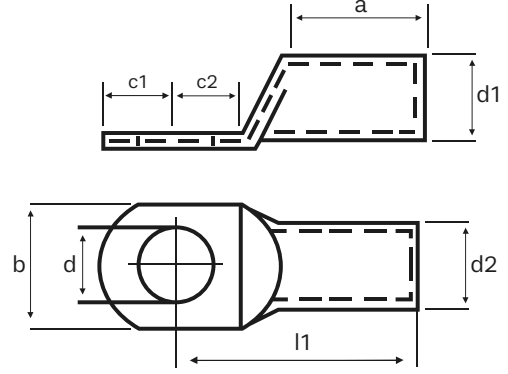
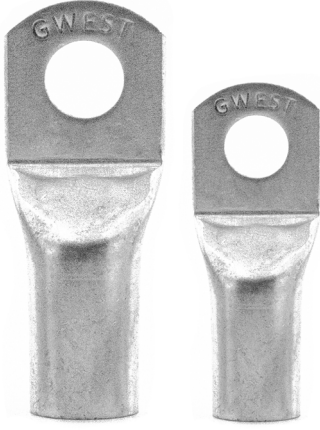

## Gwest Eko Tip Kablo Pabuçlarımız;

- EN/13600 standartlarında bakır malzemeden imal edilmiştir.
- Sıkma işlemi yapılırken kırılmayı, sıkma işlemi sonrasında gevşemeyi önlemek için üretim esnasında **tavlı bakır borular** kullanılmıştır.
- Üretimde **%99.9** oranında iletkenliğe sahip bakır kullanılmıştır.
- **5-8 Micron** aralığında **100% Kalay** kaplama yapılmaktadır.

| Sipariş Kodu | Ürün Kodu    | Kablo Kesit (mm <sup>2</sup> ) | Delik Çapı Ø | Boyutlar |      |      |      |      |      |      |      | Kutu Adet | Birim Fiyat TL / Adet |
|--------------|--------------|--------------------------------|--------------|----------|------|------|------|------|------|------|------|-----------|-----------------------|
|              |              |                                |              | d        | d1   | d2   | l1   | a    | b    | c1   | c2   |           |                       |
| 3410         | SKP-E 95-10  | 95 mm <sup>2</sup>             | M10          | 10,3     | 13,5 | 16,0 | 48,5 | 21,0 | 23,5 | 10,0 | 12,0 | 75        | 70,00                 |
| 3411         | SKP-E 95-12  |                                | M12          | 12,8     | 13,5 | 16,0 | 48,5 | 21,0 | 23,5 | 10,0 | 12,0 | 75        | 70,00                 |
| 3412         | SKP-E 120-10 | 120 mm <sup>2</sup>            | M10          | 10,5     | 15,5 | 18,0 | 58,0 | 25,0 | 26,7 | 13,0 | 14,5 | 50        | 97,00                 |
| 3413         | SKP-E 120-12 |                                | M12          | 12,8     | 15,5 | 18,0 | 58,0 | 25,0 | 26,7 | 13,0 | 14,5 | 50        | 97,00                 |
| 3414         | SKP-E 150-10 | 150 mm <sup>2</sup>            | M10          | 10,5     | 16,5 | 20,0 | 59,5 | 26,0 | 29,2 | 16,5 | 16,5 | 40        | 160,00                |
| 3415         | SKP-E 150-12 |                                | M12          | 12,8     | 16,5 | 20,0 | 59,5 | 26,0 | 29,2 | 16,5 | 16,5 | 40        | 160,00                |
| 3416         | SKP-E 185-12 | 185 mm <sup>2</sup>            | M12          | 10,5     | 18,5 | 22,0 | 65,0 | 29,0 | 32,3 | 17,0 | 18,0 | 30        | 190,00                |
| 3417         | SKP-E 185-16 |                                | M16          | 16,5     | 18,5 | 22,0 | 65,0 | 29,0 | 32,3 | 17,0 | 18,0 | 30        | 190,00                |
| 3418         | SKP-E 240-12 | 240 mm <sup>2</sup>            | M12          | 13,0     | 21,5 | 25,5 | 74,0 | 33,0 | 37,6 | 17,0 | 18,0 | 25        | 275,00                |
| 3419         | SKP-E 240-16 |                                | M16          | 16,5     | 21,5 | 25,5 | 74,0 | 33,0 | 37,6 | 17,0 | 18,0 | 25        | 275,00                |

## SKP STANDART TİP KABLO PABUCU

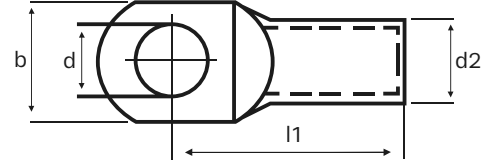
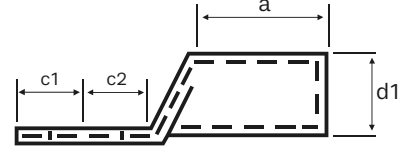
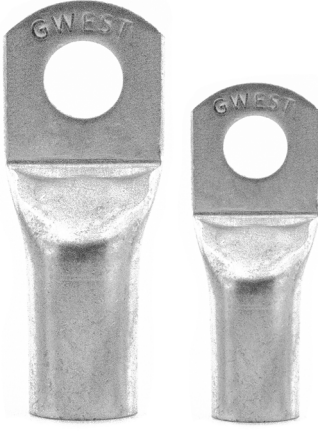

### Gwest Eko Tip Kablo Pabuçlarımız;

- EN/13600 standartlarında bakır malzemeden imal edilmiştir.
- Sıkma işlemi yapılırken kırılmayı, sıkma işlemi sonrasında gevşemeyi önlemek için üretim esnasında **tavlı bakır borular** kullanılmıştır.
- Üretimde **%99.9** oranında iletkenliğe sahip bakır kullanılmıştır.
- **5-8 Micron** aralığında **100% Kalay** kaplama yapılmaktadır.

| Sipariş Kodu | Ürün Kodu   | Kablo Kesit (mm <sup>2</sup> ) | Delik Çapı Ø | Boyutlar |      |      |      |      |      |      |      | Kutu Adet | Birim Fiyat TL / Adet |
|--------------|-------------|--------------------------------|--------------|----------|------|------|------|------|------|------|------|-----------|-----------------------|
|              |             |                                |              | d        | d1   | d2   | l1   | a    | b    | c1   | c2   |           |                       |
| 3430         | SKP-S 10-5  | 10 mm <sup>2</sup>             | M5           | 5,5      | 4,7  | 6,6  | 22,0 | 10,0 | 10,3 | 5,5  | 7,0  | 1.000     | 11,00                 |
| 3431         | SKP-S 10-6  |                                | M6           | 6,5      | 4,7  | 6,6  | 22,0 | 10,0 | 10,3 | 5,5  | 7,0  | 1.000     | 11,00                 |
| 3432         | SKP-S 10-8  |                                | M8           | 8,5      | 4,7  | 6,6  | 23,7 | 10,0 | 13,5 | 6,8  | 8,7  | 1.000     | 11,00                 |
| 3433         | SKP-S 16-6  | 16 mm <sup>2</sup>             | M6           | 6,5      | 5,6  | 7,8  | 24,0 | 12,0 | 11,2 | 5,5  | 6,5  | 500       | 15,00                 |
| 3434         | SKP-S 16-8  |                                | M8           | 8,5      | 5,6  | 7,8  | 26,2 | 12,0 | 13,5 | 6,8  | 8,7  | 500       | 18,00                 |
| 3435         | SKP-S 16-10 |                                | M10          | 10,5     | 5,6  | 7,8  | 26,0 | 12,0 | 16,0 | 7,5  | 8,5  | 500       | 18,00                 |
| 3436         | SKP-S 25-6  | 25 mm <sup>2</sup>             | M6           | 6,5      | 7,1  | 9,5  | 32,2 | 16,0 | 13,7 | 6,8  | 9,2  | 400       | 27,00                 |
| 3437         | SKP-S 25-8  |                                | M8           | 8,5      | 7,1  | 9,5  | 32,2 | 16,0 | 13,7 | 6,8  | 9,2  | 400       | 27,00                 |
| 3438         | SKP-S 25-10 |                                | M10          | 10,5     | 7,1  | 9,5  | 34,0 | 16,0 | 16,0 | 8,0  | 11,0 | 300       | 28,00                 |
| 3439         | SKP-S 35-6  | 35 mm <sup>2</sup>             | M6           | 6,5      | 8,2  | 10,8 | 35,7 | 19,0 | 15,3 | 8,3  | 9,7  | 200       | 37,00                 |
| 3440         | SKP-S 35-8  |                                | M8           | 8,5      | 8,2  | 10,8 | 35,7 | 19,0 | 15,3 | 8,3  | 9,7  | 200       | 37,00                 |
| 3441         | SKP-S 35-10 |                                | M10          | 10,5     | 8,2  | 10,8 | 38,0 | 19,0 | 15,7 | 10,0 | 12,0 | 200       | 40,00                 |
| 3391         | SKP-S 35-12 |                                | M12          | 13,0     | 8,2  | 10,8 | 38,0 | 19,0 | 18,0 | 10,0 | 12,0 | 150       | 40,00                 |
| 3389         | SKP-S 50-6  | 50 mm <sup>2</sup>             | M6           | 6,5      | 10,1 | 13,0 | 39,2 | 21,0 | 18,9 | 8,3  | 9,7  | 150       | 54,00                 |
| 3442         | SKP-S 50-8  |                                | M8           | 8,5      | 10,1 | 13,0 | 39,2 | 21,0 | 18,9 | 8,3  | 9,7  | 150       | 54,00                 |
| 3443         | SKP-S 50-10 |                                | M10          | 10,5     | 10,1 | 13,0 | 41,5 | 21,0 | 18,9 | 10,0 | 12,0 | 150       | 58,00                 |
| 3444         | SKP-S 50-12 |                                | M12          | 13,0     | 10,1 | 13,0 | 41,5 | 21,0 | 18,9 | 10,0 | 12,0 | 150       | 58,00                 |
| 3446         | SKP-S 70-8  | 70 mm <sup>2</sup>             | M8           | 8,5      | 11,5 | 14,7 | 42,3 | 23,0 | 21,1 | 8,3  | 9,7  | 100       | 77,00                 |
| 3447         | SKP-S 70-10 |                                | M10          | 10,5     | 11,5 | 14,7 | 44,6 | 23,0 | 21,1 | 10,0 | 12,0 | 100       | 77,00                 |
| 3448         | SKP-S 70-12 |                                | M12          | 13,0     | 11,5 | 14,7 | 44,6 | 23,0 | 21,1 | 10,0 | 12,0 | 100       | 77,00                 |
| 3449         | SKP-S 70-14 |                                | M14          | 15,0     | 11,5 | 14,7 | 47,6 | 23,0 | 21,5 | 15,0 | 15,0 | 100       | 86,00                 |
| 3392         | SKP-S 70-16 |                                | M16          | 17,0     | 11,5 | 14,7 | 47,6 | 23,0 | 21,5 | 15,0 | 15,0 | 100       | 86,00                 |

## SKP STANDART TİP KABLO PABUCU

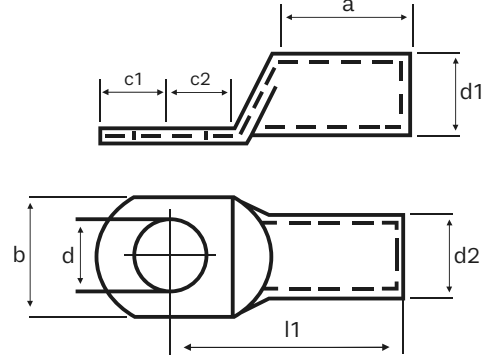

## Gwest Eko Tip Kablo Pabuçlarımız;

- EN/13600 standartlarında bakır malzemeden imal edilmiştir.
- Sıkma işlemi yapılırken kırılmayı, sıkma işlemi sonrasında gevşemeyi önlemek için üretim esnasında **tavlı bakır borular** kullanılmıştır.
- Üretimde **%99.9** oranında iletkenliğe sahip bakır kullanılmıştır.
- **5-8 Micron** aralığında **100% Kalay** kaplama yapılmaktadır.

| Sipariş Kodu | Ürün Kodu    | Kablo Kesit (mm <sup>2</sup> ) | Delik Çapı Ø | Boyutlar |      |      |      |      |      |      |      | Kutu Adet | Birim Fiyat TL / Adet |
|--------------|--------------|--------------------------------|--------------|----------|------|------|------|------|------|------|------|-----------|-----------------------|
|              |              |                                |              | d        | d1   | d2   | l1   | a    | b    | c1   | c2   |           |                       |
| 3450         | SKP-S 95-8   | 95 mm <sup>2</sup>             | M8           | 8,5      | 13,5 | 16,7 | 48,8 | 26,0 | 24,7 | 10,0 | 12,0 | 75        | 95,00                 |
| 3451         | SKP-S 95-10  |                                | M10          | 10,5     | 13,5 | 16,7 | 48,8 | 26,0 | 24,7 | 10,0 | 12,0 | 75        | 95,00                 |
| 3452         | SKP-S 95-12  |                                | M12          | 13,0     | 13,5 | 16,7 | 48,8 | 26,0 | 24,7 | 10,0 | 12,0 | 75        | 95,00                 |
| 3453         | SKP-S 120-10 | 120 mm <sup>2</sup>            | M10          | 10,5     | 15,6 | 19,0 | 56,0 | 29,0 | 27,7 | 13,0 | 14,5 | 50        | 135,00                |
| 3454         | SKP-S 120-12 |                                | M12          | 13,0     | 15,6 | 19,0 | 56,0 | 29,0 | 27,7 | 13,0 | 14,5 | 50        | 135,00                |
| 3393         | SKP-S 120-14 |                                | M14          | 15,0     | 15,6 | 19,0 | 56,0 | 29,0 | 27,7 | 13,0 | 14,5 | 50        | 135,00                |
| 3455         | SKP-S 120-16 |                                | M16          | 17,0     | 15,6 | 19,0 | 56,0 | 29,0 | 27,7 | 13,0 | 14,5 | 50        | 135,00                |
| 3456         | SKP-S 150-10 | 150 mm <sup>2</sup>            | M10          | 10,5     | 16,5 | 21,0 | 60,0 | 30,0 | 30,4 | 16,5 | 16,5 | 40        | 213,00                |
| 3457         | SKP-S 150-12 |                                | M12          | 13,0     | 16,5 | 21,0 | 60,0 | 30,0 | 30,4 | 16,5 | 16,5 | 40        | 213,00                |
| 3394         | SKP-S 150-14 |                                | M14          | 15,0     | 16,5 | 21,0 | 60,0 | 30,0 | 30,4 | 16,5 | 16,5 | 40        | 213,00                |
| 3458         | SKP-S 150-16 |                                | M16          | 17,0     | 16,5 | 21,0 | 60,0 | 30,0 | 30,4 | 16,5 | 16,5 | 40        | 213,00                |
| 3395         | SKP-S 185-10 | 185 mm <sup>2</sup>            | M10          | 10,5     | 18,4 | 23,0 | 65,5 | 33,0 | 34,2 | 17,0 | 18,0 | 30        | 264,00                |
| 3459         | SKP-S 185-12 |                                | M12          | 13,0     | 18,4 | 23,0 | 65,5 | 33,0 | 34,2 | 17,0 | 18,0 | 30        | 264,00                |
| 3396         | SKP-S 185-14 |                                | M14          | 15,0     | 18,4 | 23,0 | 65,5 | 33,0 | 34,2 | 17,0 | 18,0 | 30        | 264,00                |
| 3460         | SKP-S 185-16 |                                | M16          | 17,0     | 18,4 | 23,0 | 65,5 | 33,0 | 34,2 | 17,0 | 18,0 | 30        | 264,00                |
| 3397         | SKP-S 240-10 | 240 mm <sup>2</sup>            | M10          | 10,5     | 21,0 | 26,0 | 72,0 | 38,0 | 38,7 | 17,0 | 18,0 | 25        | 345,00                |
| 3461         | SKP-S 240-12 |                                | M12          | 13,0     | 21,0 | 26,0 | 72,0 | 38,0 | 38,7 | 17,0 | 18,0 | 25        | 345,00                |
| 3398         | SKP-S 240-14 |                                | M14          | 15,0     | 21,0 | 26,0 | 72,0 | 38,0 | 38,7 | 17,0 | 18,0 | 25        | 345,00                |
| 3462         | SKP-S 240-16 |                                | M16          | 17,0     | 21,0 | 26,0 | 72,0 | 38,0 | 38,7 | 17,0 | 18,0 | 25        | 345,00                |
| 3399         | SKP-S 300-12 | 300 mm <sup>2</sup>            | M12          | 13,0     | 23,4 | 28,6 | 77,0 | 41,0 | 42,6 | 18,0 | 18,0 | 20        | 420,00                |
| 3463         | SKP-S 300-14 |                                | M14          | 15,0     | 23,4 | 28,6 | 77,0 | 41,0 | 42,6 | 18,0 | 18,0 | 20        | 420,00                |
| 3464         | SKP-S 300-16 |                                | M16          | 17,0     | 23,4 | 28,6 | 77,0 | 41,0 | 42,6 | 18,0 | 18,0 | 20        | 420,00                |

## DIN 46235 TİPİ KABLO PABUCU



- EN/13600 standartlarında bakır malzemeden imal edilmiştir.
- Sıkma işlemi yapılırken kırılmayı, sıkma işlemi sonrasında gevşemeyi önlemek için üretim esnasında **tavlı bakır borular** kullanılmıştır.
- Üretimde **%99.9** oranında iletkenliğe sahip bakır kullanılmıştır.
- **5-8 Micron** aralığında **100% Kalay** kaplama yapılmaktadır.

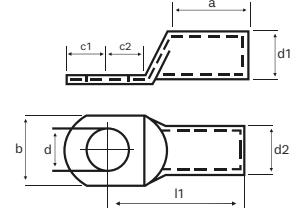

| Sipariş Kodu | Ürün Kodu   | Kablo Kesit (mm <sup>2</sup> ) | Delik Çapı Ø | Boyutlar (mm) |      |      |      |      |      |      |      | Kutu Adet | Birim Fiyat TL / Adet |
|--------------|-------------|--------------------------------|--------------|---------------|------|------|------|------|------|------|------|-----------|-----------------------|
|              |             |                                |              | d             | d1   | d2   | l1   | a    | b    | c1   | c2   |           |                       |
| 7000         | SKP-D 10-5  | 10 mm <sup>2</sup>             | M5           | 5,3           | 4,5  | 7,0  | 27,0 | 10,0 | 9,0  | 7,0  | 8,5  | 500       | <b>16,00</b>          |
| 7001         | SKP-D 10-6  |                                | M6           | 6,4           | 4,5  | 7,0  | 27,0 | 10,0 | 9,0  | 7,5  | 8,5  |           |                       |
| 7002         | SKP-D 16-6  | 16 mm <sup>2</sup>             | M6           | 6,4           | 5,5  | 8,5  | 36,0 | 20,0 | 13,0 | 7,5  | 8,0  | 250       | <b>33,00</b>          |
| 7003         | SKP-D 16-8  |                                | M8           | 8,4           | 5,5  | 8,5  | 36,0 | 20,0 | 13,0 | 10,0 | 10,0 |           |                       |
| 7004         | SKP-D 16-10 |                                | M10          | 10,5          | 5,5  | 8,5  | 36,0 | 20,0 | 17,0 | 12,0 | 12,0 |           |                       |
| 7005         | SKP-D 25-6  | 25 mm <sup>2</sup>             | M6           | 6,4           | 7,0  | 10,0 | 38,0 | 20,0 | 14,0 | 7,5  | 8,0  | 200       | <b>44,00</b>          |
| 7006         | SKP-D 25-8  |                                | M8           | 8,4           | 7,0  | 10,0 | 38,0 | 20,0 | 16,0 | 10,0 | 10,0 |           |                       |
| 7007         | SKP-D 25-10 |                                | M10          | 10,5          | 7,0  | 10,0 | 38,0 | 20,0 | 17,0 | 12,0 | 12,0 |           |                       |
| 7008         | SKP-D 25-12 |                                | M12          | 13,0          | 7,0  | 10,0 | 38,0 | 20,0 | 19,0 | 13,0 | 13,0 |           |                       |
| 7009         | SKP-D 35-8  | 35 mm <sup>2</sup>             | M8           | 8,4           | 8,2  | 12,5 | 42,0 | 20,0 | 17,0 | 10,0 | 10,0 | 120       | <b>80,00</b>          |
| 7010         | SKP-D 35-10 |                                | M10          | 10,5          | 8,2  | 12,5 | 42,0 | 20,0 | 19,0 | 12,0 | 12,0 |           |                       |
| 7011         | SKP-D 35-12 |                                | M12          | 13,0          | 8,2  | 12,5 | 42,0 | 20,0 | 21,0 | 13,0 | 13,0 |           |                       |
| 7012         | SKP-D 50-8  | 50 mm <sup>2</sup>             | M8           | 8,4           | 10,0 | 14,5 | 52,0 | 28,0 | 20,0 | 10,0 | 10,0 | 65        | <b>120,00</b>         |
| 7013         | SKP-D 50-10 |                                | M10          | 10,5          | 10,0 | 14,5 | 52,0 | 28,0 | 22,0 | 12,0 | 12,0 |           |                       |
| 7014         | SKP-D 50-12 |                                | M12          | 13,0          | 10,0 | 14,5 | 52,0 | 28,0 | 24,0 | 13,0 | 13,0 |           |                       |
| 7015         | SKP-D 50-16 |                                | M16          | 17,0          | 10,0 | 14,5 | 52,0 | 28,0 | 28,0 | 16,0 | 16,0 |           |                       |
| 7016         | SKP-D 70-8  | 70 mm <sup>2</sup>             | M8           | 8,4           | 11,5 | 16,5 | 55,0 | 28,0 | 24,0 | 10,0 | 10,0 | 50        | <b>165,00</b>         |
| 7017         | SKP-D 70-10 |                                | M10          | 10,5          | 11,5 | 16,5 | 55,0 | 28,0 | 24,0 | 12,0 | 12,0 |           |                       |
| 7018         | SKP-D 70-12 |                                | M12          | 13,0          | 11,5 | 16,5 | 55,0 | 28,0 | 24,0 | 13,0 | 13,0 |           |                       |
| 7019         | SKP-D 70-16 |                                | M16          | 17,0          | 11,5 | 16,5 | 55,0 | 28,0 | 30,0 | 16,0 | 16,0 |           |                       |

## DIN 46235 TİPİ KABLO PABUCU



- EN/13600 standartlarında bakır malzemeden imal edilmiştir.
- Sıkma işlemi yapılırken kırılmayı, sıkma işlemi sonrasında gevşemeyi önlemek için üretim esnasında **tavlı bakır borular** kullanılmıştır.
- Üretimde **%99.9** oranında iletkenliğe sahip bakır kullanılmıştır.
- **5-8 Micron** aralığında **100% Kalay** kaplama yapılmaktadır.

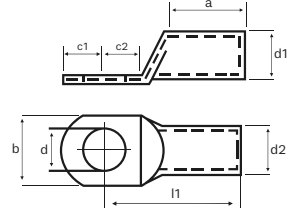

| Sipariş Kodu | Ürün Kodu    | Kablo Kesit (mm <sup>2</sup> ) | Delik Çapı Ø | Boyutlar (mm) |      |      |       |      |      |      |      | Kutu Adet | Birim Fiyat TL / Adet |
|--------------|--------------|--------------------------------|--------------|---------------|------|------|-------|------|------|------|------|-----------|-----------------------|
|              |              |                                |              | d             | d1   | d2   | l1    | a    | b    | c1   | c2   |           |                       |
| 7020         | SKP-D 95-10  | 95 mm <sup>2</sup>             | M10          | 10,5          | 13,5 | 19,0 | 65,0  | 35,0 | 28,0 | 12,0 | 12,0 | 30        | <b>230,00</b>         |
| 7021         | SKP-D 95-12  |                                | M12          | 13,0          | 13,5 | 19,0 | 65,0  | 35,0 | 28,0 | 13,0 | 13,0 | 30        | <b>230,00</b>         |
| 7022         | SKP-D 95-16  |                                | M16          | 17,0          | 13,5 | 19,0 | 65,0  | 35,0 | 32,0 | 16,0 | 16,0 | 30        | <b>230,00</b>         |
| 7023         | SKP-D 120-10 | 120 mm <sup>2</sup>            | M10          | 10,5          | 15,5 | 21,0 | 70,0  | 35,0 | 32,0 | 15,0 | 16,0 | 25        | <b>300,00</b>         |
| 7024         | SKP-D 120-12 |                                | M12          | 13,0          | 15,5 | 21,0 | 70,0  | 35,0 | 32,0 | 16,0 | 17,0 | 25        | <b>300,00</b>         |
| 7025         | SKP-D 120-16 |                                | M16          | 17,0          | 15,5 | 21,0 | 70,0  | 35,0 | 32,0 | 19,0 | 20,0 | 25        | <b>300,00</b>         |
| 7026         | SKP-D 120-20 |                                | M20          | 21,0          | 15,5 | 21,0 | 70,0  | 35,0 | 38,0 | 21,0 | 22,0 | 25        | <b>300,00</b>         |
| 7027         | SKP-D 150-10 | 150 mm <sup>2</sup>            | M10          | 10,5          | 17,0 | 23,5 | 78,0  | 35,0 | 34,0 | 15,0 | 16,0 | 20        | <b>415,00</b>         |
| 7028         | SKP-D 150-12 |                                | M12          | 13,0          | 17,0 | 23,5 | 78,0  | 35,0 | 34,0 | 16,0 | 17,0 | 20        | <b>415,00</b>         |
| 7029         | SKP-D 150-16 |                                | M16          | 17,0          | 17,0 | 23,5 | 78,0  | 35,0 | 34,0 | 19,0 | 20,0 | 20        | <b>415,00</b>         |
| 7030         | SKP-D 150-20 |                                | M20          | 21,0          | 17,0 | 23,5 | 78,0  | 35,0 | 40,0 | 21,0 | 22,0 | 20        | <b>415,00</b>         |
| 7031         | SKP-D 185-10 | 185 mm <sup>2</sup>            | M10          | 10,5          | 19,0 | 25,5 | 82,0  | 40,0 | 37,0 | 15,0 | 16,0 | 15        | <b>490,00</b>         |
| 7032         | SKP-D 185-12 |                                | M12          | 13,0          | 19,0 | 25,5 | 82,0  | 40,0 | 37,0 | 16,0 | 17,0 | 15        | <b>490,00</b>         |
| 7033         | SKP-D 185-16 |                                | M16          | 17,0          | 19,0 | 25,5 | 82,0  | 40,0 | 37,0 | 19,0 | 20,0 | 15        | <b>490,00</b>         |
| 7034         | SKP-D 185-20 |                                | M20          | 21,0          | 19,0 | 25,5 | 82,0  | 40,0 | 40,0 | 21,0 | 22,0 | 15        | <b>490,00</b>         |
| 7035         | SKP-D 240-12 | 240 mm <sup>2</sup>            | M12          | 13,0          | 21,5 | 29,0 | 92,0  | 40,0 | 42,0 | 16,0 | 17,0 | 10        | <b>700,00</b>         |
| 7036         | SKP-D 240-16 |                                | M16          | 17,0          | 21,5 | 29,0 | 92,0  | 40,0 | 42,0 | 19,0 | 20,0 | 10        | <b>700,00</b>         |
| 7037         | SKP-D 240-20 |                                | M20          | 21,0          | 21,5 | 29,0 | 92,0  | 40,0 | 45,0 | 21,0 | 22,0 | 10        | <b>700,00</b>         |
| 7038         | SKP-D 300-16 | 300 mm <sup>2</sup>            | M16          | 17,0          | 24,5 | 32,0 | 100,0 | 50,0 | 48,0 | 19,0 | 22,0 | 10        | <b>800,00</b>         |
| 7039         | SKP-D 300-20 |                                | M20          | 21,0          | 24,5 | 32,0 | 100,0 | 50,0 | 48,0 | 22,0 | 22,0 | 10        | <b>800,00</b>         |



# BİMETAL (AL-CU) KABLO PAPUCU



## Teknik Özellikler

İletken Malzeme

Malzeme : %99.9 Alüminyum ve Bakır

Çekme Derecesi : 110MPa

Çalışma Sıcaklığı : - 40 ° C --- +100 ° C



| Sipariş Kodu | Ürün Kodu     | Kablo Kesit (mm <sup>2</sup> ) | Delik Çapı Ø | Boyutlar (mm) |    |      |     |    | Kutu Adet | Koli Adet | Birim Fiyat TL / Adet |
|--------------|---------------|--------------------------------|--------------|---------------|----|------|-----|----|-----------|-----------|-----------------------|
|              |               |                                |              | d             | D  | II   | L   | B  |           |           |                       |
| 7050         | SKP-BM 16-10  | 16 mm <sup>2</sup>             | M10          | 6             | 16 | 41   | 82  | 24 | 100       | 600       | 92,00                 |
| 7051         | SKP-BM 25-10  | 25 mm <sup>2</sup>             | M10          | 7             | 16 | 41   | 82  | 24 | 100       | 600       | 92,00                 |
| 7052         | SKP-BM 35-10  | 35 mm <sup>2</sup>             | M10          | 8,5           | 16 | 41   | 82  | 24 | 100       | 600       | 92,00                 |
| 7053         | SKP-BM 50-12  | 50 mm <sup>2</sup>             | M12          | 9,8           | 20 | 49   | 90  | 25 | 50        | 300       | 127,00                |
| 7054         | SKP-BM 70-12  | 70 mm <sup>2</sup>             | M12          | 11,6          | 20 | 49   | 90  | 25 | 50        | 300       | 127,00                |
| 7055         | SKP-BM 95-12  | 95 mm <sup>2</sup>             | M12          | 13,8          | 20 | 49   | 90  | 25 | 50        | 300       | 127,00                |
| 7056         | SKP-BM 120-12 | 120 mm <sup>2</sup>            | M12          | 15,5          | 25 | 60   | 113 | 28 | 30        | 180       | 220,00                |
| 7057         | SKP-BM 150-12 | 150 mm <sup>2</sup>            | M12          | 17            | 25 | 60   | 113 | 28 | 30        | 180       | 220,00                |
| 7058         | SKP-BM 185-12 | 185 mm <sup>2</sup>            | M12          | 18,5          | 32 | 65   | 130 | 35 | 20        | 120       | 370,00                |
| 7059         | SKP-BM 240-12 | 240 mm <sup>2</sup>            | M12          | 21,5          | 32 | 65   | 130 | 35 | 20        | 120       | 370,00                |
| 7060         | SKP-BM 300-12 | 300 mm <sup>2</sup>            | M12          | 24            | 34 | 70,8 | 135 | 36 | 15        | 90        | 440,00                |
| 7061         | SKP-BM 400-16 | 400 mm <sup>2</sup>            | M16          | 26            | 34 | 70,8 | 135 | 36 | 9         | 54        | 660,00                |

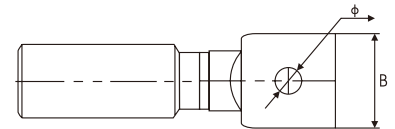
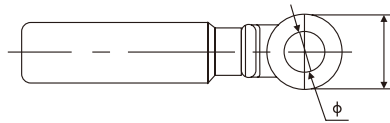
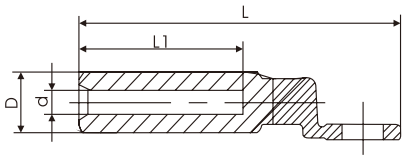

## Açıklama

Bimetal kablo pabuçları, alüminyum iletkenlerle, dağıtım ekipmanlarındaki güç kabloları ve elektrik ekipmanlarının bakır terminallerine bağlantısında kullanılan kablo pabuçu çeşididir. Kullanılan alüminyum ve bakır elektrolitik özellikli olup iletkenlik derecesi çok iyidir.



## EK MUFLARI



## Gwest Ek Muflarımız;

- EN/13600 standartlarında bakır malzemeden imal edilmiştir.
- Sıkma işlemi yapılırken kırılmayı, sıkma işlemi sonrasında gevşemeyi önlemek için üretim esnasında **tavlı bakır borular** kullanılmıştır.
- Üretimde **%99.9** oranında iletkenliğe sahip bakır kullanılmıştır.
- **5-8 Micron** aralığında **100% Kalay** kaplama yapılmaktadır.

| Sipariş Kodu | Ürün Kodu   | Kablo Kesit (mm <sup>2</sup> ) | Boyutlar (mm) |      |       | Kutu Adet | Birim Fiyat TL / Adet |
|--------------|-------------|--------------------------------|---------------|------|-------|-----------|-----------------------|
|              |             |                                | A             | B    | C     |           |                       |
| 3465         | EKMUF - 10  | 10                             | 4.7           | 6.6  | 30.0  | 1.000     | <b>11,00</b>          |
| 3466         | EKMUF - 16  | 16                             | 5.5           | 7.0  | 35.0  | 500       | <b>12,00</b>          |
| 3467         | EKMUF - 25  | 25                             | 7.0           | 9.0  | 40.0  | 300       | <b>20,00</b>          |
| 3468         | EKMUF - 35  | 35                             | 8.5           | 10.5 | 45.0  | 200       | <b>27,00</b>          |
| 3469         | EKMUF - 50  | 50                             | 10.0          | 12.0 | 50.0  | 100       | <b>38,00</b>          |
| 3470         | EKMUF - 70  | 70                             | 11.5          | 14.0 | 55.0  | 75        | <b>58,00</b>          |
| 3471         | EKMUF - 95  | 95                             | 13.5          | 16.0 | 60.0  | 50        | <b>70,00</b>          |
| 3472         | EKMUF - 120 | 120                            | 15.5          | 18.0 | 65.0  | 50        | <b>95,00</b>          |
| 3473         | EKMUF - 150 | 150                            | 16.5          | 20.0 | 70.0  | 30        | <b>155,00</b>         |
| 3474         | EKMUF - 185 | 185                            | 18.5          | 22.0 | 75.0  | 25        | <b>185,00</b>         |
| 3475         | EKMUF - 240 | 240                            | 21.5          | 25.5 | 85.0  | 20        | <b>270,00</b>         |
| 3492         | EKMUF - 300 | 300                            | 23.5          | 28.5 | 100.0 | 15        | <b>420,00</b>         |

## DELİKLİ MONTAJ RAYLARI



**Malzeme** : Galvaniz Kaplama  
**Dış Genişlik** : 35mm  
**İç Genişlik** : 27mm  
**Derinlik** : 7,5mm



| Sipariş Kodu | Ürün Kodu   | Uzunluk | Kutu Adet | Birim Fiyat TL / Adet |
|--------------|-------------|---------|-----------|-----------------------|
| 3494         | GW - MR 030 | 30 cm   | 150       | <b>18,00</b>          |
| 3495         | GW - MR 1   | 1 m     | 50        | <b>50,00</b>          |
| 3496         | GW - MR 2   | 2 m     | 30        | <b>100,00</b>         |

## DÜZ MONTAJ RAYLARI



**Malzeme** : Galvaniz Kaplama  
**Dış Genişlik** : 35mm  
**İç Genişlik** : 27mm  
**Derinlik** : 7,5mm



| Sipariş Kodu | Ürün Kodu    | Uzunluk | Kutu Adet | Birim Fiyat TL / Adet |
|--------------|--------------|---------|-----------|-----------------------|
| 3497         | GW - MRD 030 | 30 cm   | 150       | <b>18,00</b>          |
| 3498         | GW - MRD 1   | 1 m     | 50        | <b>50,00</b>          |
| 3499         | GW - MRD 2   | 2 m     | 30        | <b>100,00</b>         |

## MONOFAZE MÜŞTEREK W OTOMAT BARALARI



| Sipariş Kodu | Ürün Kodu | Bakır Kalınlığı | Boy    | Modül          | Amper | Kutu Adet | Fiyat TL / Adet |
|--------------|-----------|-----------------|--------|----------------|-------|-----------|-----------------|
| 3599         | M - 5308  | 0.8 mm          | 53 cm  | 30 Otomat için | 63 A  | 60        | 150,00          |
| 3600         | M - 10608 | 0.8 mm          | 106 cm | 60 Otomat için | 63 A  | 60        | 300,00          |
| 3601         | M - 531   | 1 mm            | 53 cm  | 30 Otomat için | 80 A  | 60        | 180,00          |
| 3602         | M - 1061  | 1 mm            | 106 cm | 60 Otomat için | 80 A  | 60        | 360,00          |
| 3603         | M - 5315  | 1.5 mm          | 53 cm  | 30 Otomat için | 100 A | 60        | 270,00          |
| 3604         | M - 10615 | 1.5 mm          | 106 cm | 60 Otomat için | 100 A | 60        | 540,00          |

## TRİFAZE MÜŞTEREK W OTOMAT BARALARI

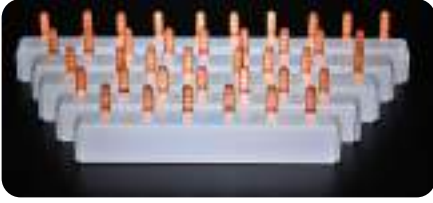

| Sipariş Kodu | Ürün Kodu | Bakır Kalınlığı | Boy    | Modül                | Amper | Kutu Adet | Fiyat TL / Adet |
|--------------|-----------|-----------------|--------|----------------------|-------|-----------|-----------------|
| 3632         | T - 5308  | 0.8 mm          | 53 cm  | 10 Grup için         | 63 A  | 24        | 450,00          |
| 3633         | T - 10608 | 0.8 mm          | 106 cm | 20 Grup için         | 63 A  | 24        | 900,00          |
| 3608         | T - 531   | 1 mm            | 53 cm  | 10 Grup için         | 80 A  | 24        | 550,00          |
| 3609         | T - 1061  | 1 mm            | 106 cm | 20 Grup için         | 80 A  | 24        | 1.100,00        |
| 3613         | T - 5315  | 1,5 mm          | 53 cm  | 10 Grup için         | 100 A | 24        | 800,00          |
| 3614         | T - 10615 | 1,5 mm          | 106 cm | 20 Grup için         | 100 A | 24        | 1.600,00        |
| 3627         |           | Gwest - KAP     |        | Monofaze Bara Kapağı |       |           | 10,00           |
| 3628         |           | Gwest - KAP     |        | Trifaze Bara Kapağı  |       |           | 10,00           |

İSTEDİĞİNİZ ÖLÇÜDE KESİM YAPILIR.

## 2 KUTUPLU DAĞITICI ÜNİTELER

|                                |                         |  |
|--------------------------------|-------------------------|--|
| Birim Fiyat TL / Adet          | <b>265,00</b>           |  |
| Sipariş Kodu                   | 3701                    |  |
| Ürün Kodu                      | <b>GW - 2x7</b>         |  |
| Akım                           | 125 Amper               |  |
| Kablo Cinsi                    | Tek Damar               | Çok Telli  |
| Kablo Kesit (mm <sup>2</sup> ) | <b>Giriş</b>            | <b>Çıkış</b>                                       |
|                                | 1x10-35 mm <sup>2</sup> | 1x10-25 mm <sup>2</sup><br>5x2,5-6 mm <sup>2</sup> |
|                                | 1x10-16 mm <sup>2</sup> | 1x6-16 mm <sup>2</sup><br>5x1,5-6 mm <sup>2</sup>  |
| Ambalaj Adet                   | <b>Paket</b>            | <b>Koli</b>  |
|                                | 1                       | 138  |



|                                |                         |  |
|--------------------------------|-------------------------|--|
| Birim Fiyat TL / Adet          | <b>380,00</b>           |  |
| Sipariş Kodu                   | 3702                    |  |
| Ürün Kodu                      | <b>GW - 2x11</b>        |  |
| Akım                           | 125 Amper               |  |
| Kablo Cinsi                    | Tek Damar               | Çok Telli  |
| Kablo Kesit (mm <sup>2</sup> ) | <b>Giriş</b>            | <b>Çıkış</b>                                       |
|                                | 2x10-35 mm <sup>2</sup> | 2x10-25 mm <sup>2</sup><br>7x2,5-6 mm <sup>2</sup> |
|                                | 2x10-16 mm <sup>2</sup> | 2x6-16 mm <sup>2</sup><br>7x1,5-6 mm <sup>2</sup>  |
| Ambalaj Adet                   | <b>Paket</b>            | <b>Koli</b>  |
|                                | 1                       | 84   |



|                                |                         |   |
|--------------------------------|-------------------------|---|
| Birim Fiyat TL / Adet          | <b>490,00</b>           |   |
| Sipariş Kodu                   | 3703                    |   |
| Ürün Kodu                      | <b>GW - 2x15</b>        |   |
| Akım                           | 125 Amper               |   |
| Kablo Cinsi                    | Tek Damar               | Çok Telli   |
| Kablo Kesit (mm <sup>2</sup> ) | <b>Giriş</b>            | <b>Çıkış</b>  |
|                                | 2x10-35 mm <sup>2</sup> | 2x10-25 mm <sup>2</sup><br>11x2,5-6 mm <sup>2</sup> |
|                                | 2x10-16 mm <sup>2</sup> | 2x6-16 mm <sup>2</sup><br>11x1,5-6 mm <sup>2</sup>  |
| Ambalaj Adet                   | <b>Paket</b>            | <b>Koli</b>   |
|                                | 1                       | 72  |





## 4 KUTUPLU DAĞITICI ÜNİTELER



|                                |                         |  |
|--------------------------------|-------------------------|--|
| Birim Fiyat TL / Adet          | <b>490,00</b>           |  |
| Sipariş Kodu                   | 3704                    |  |
| Ürün Kodu                      | <b>GW - 4x7</b>         |  |
| Akım                           | 125 Amper               |  |
| Kablo Cinsi                    | Tek Damar               | Çok Tellî  |
| Kablo Kesit (mm <sup>2</sup> ) | <b>Giriş</b>            | <b>Çıkış</b>                                       |
|                                | 1x10-35 mm <sup>2</sup> | 1x10-25 mm <sup>2</sup><br>5x2,5-6 mm <sup>2</sup> |
|                                | 1x10-16 mm <sup>2</sup> | 1x6-16 mm <sup>2</sup><br>5x1,5-6 mm <sup>2</sup>  |
| Ambalaj Adet                   | <b>Paket</b>            | <b>Koli</b>  |
|                                | 1                       | 74   |



|                                |                         |  |
|--------------------------------|-------------------------|--|
| Birim Fiyat TL / Adet          | <b>740,00</b>           |  |
| Sipariş Kodu                   | 3705                    |  |
| Ürün Kodu                      | <b>GW - 4x11</b>        |  |
| Akım                           | 125 Amper               |  |
| Kablo Cinsi                    | Tek Damar               | Çok Tellî  |
| Kablo Kesit (mm <sup>2</sup> ) | <b>Giriş</b>            | <b>Çıkış</b>                                       |
|                                | 2x10-35 mm <sup>2</sup> | 2x10-25 mm <sup>2</sup><br>7x2,5-6 mm <sup>2</sup> |
|                                | 2x10-16 mm <sup>2</sup> | 2x6-16 mm <sup>2</sup><br>7x1,5-6 mm <sup>2</sup>  |
| Ambalaj Adet                   | <b>Paket</b>            | <b>Koli</b>  |
|                                | 1                       | 50   |



|                                |                         |   |
|--------------------------------|-------------------------|---|
| Birim Fiyat TL / Adet          | <b>900,00</b>           |   |
| Sipariş Kodu                   | 3706                    |   |
| Ürün Kodu                      | <b>GW - 4x15</b>        |   |
| Akım                           | 125 Amper               |   |
| Kablo Cinsi                    | Tek Damar               | Çok Tellî   |
| Kablo Kesit (mm <sup>2</sup> ) | <b>Giriş</b>            | <b>Çıkış</b>  |
|                                | 2x10-35 mm <sup>2</sup> | 2x10-25 mm <sup>2</sup><br>11x2,5-6 mm <sup>2</sup> |
|                                | 2x10-16 mm <sup>2</sup> | 2x6-16 mm <sup>2</sup><br>11x1,5-6 mm <sup>2</sup>  |
| Ambalaj Adet                   | <b>Paket</b>            | <b>Koli</b>   |
|                                | 1                       | 40  |



|                                |                         |   |
|--------------------------------|-------------------------|---|
| Birim Fiyat TL / Adet          | <b>2.200,00</b>         |   |
| Sipariş Kodu                   | 3707                    |   |
| Ürün Kodu                      | <b>GW - 4x12/160A</b>   |   |
| Akım                           | 160 Amper               |   |
| Kablo Cinsi                    | Tek Damar               | Çok Tellî   |
| Kablo Kesit (mm <sup>2</sup> ) | <b>Giriş</b>            | <b>Çıkış</b>  |
|                                | 1x10-50 mm <sup>2</sup> | 3x10-35 mm <sup>2</sup><br>8x2,5-16 mm <sup>2</sup> |
|                                | 1x10-50 mm <sup>2</sup> | 3x6-25 mm <sup>2</sup><br>8x1,5-16 mm <sup>2</sup>  |
| Ambalaj Adet                   | <b>Paket</b>            | <b>Koli</b>   |
|                                | 1                       | 18  |

## TEK KUTUPLU DAĞITICI ÜNİTELER

|                                   |                         |   |
|-----------------------------------|-------------------------|---|
| Birim Fiyat<br>TL / Adet          | <b>220,00</b>           |   |
| Sipariş Kodu                      | 3708                    |   |
| Ürün Kodu                         | <b>GW - 80A</b>         |   |
| Akım                              | 80 Amper                |   |
| Kablo Kesit<br>(mm <sup>2</sup> ) | <b>Giriş</b>            | <b>Çıkış</b>  |
|                                   | 1x10-16 mm <sup>2</sup> | 4x2,5-6 mm <sup>2</sup><br>2x2,5-16 mm <sup>2</sup> |
| Ambalaj Adet                      | <b>Paket</b>            | <b>Koli</b>   |
|                                   | 5                       | 250   |



|                                   |                         |  |
|-----------------------------------|-------------------------|--|
| Birim Fiyat<br>TL / Adet          | <b>460,00</b>           |  |
| Sipariş Kodu                      | 3709                    |  |
| Ürün Kodu                         | <b>GW - 125A</b>        |  |
| Akım                              | 125 Amper               |  |
| Kablo Kesit<br>(mm <sup>2</sup> ) | <b>Giriş</b>            | <b>Çıkış</b>   |
|                                   | 1x10-35 mm <sup>2</sup> | 6x2,5-16 mm <sup>2</sup><br>Köprü 1x6-16 mm <sup>2</sup> |
| Ambalaj Adet                      | <b>Paket</b>            | <b>Koli</b>  |
|                                   | 5                       | 160  |



|                                   |                         |  |
|-----------------------------------|-------------------------|--|
| Birim Fiyat<br>TL / Adet          | <b>470,00</b>           |  |
| Sipariş Kodu                      | 3710                    |  |
| Ürün Kodu                         | <b>GW - 160A</b>        |  |
| Akım                              | 160 Amper               |  |
| Kablo Kesit<br>(mm <sup>2</sup> ) | <b>Giriş</b>            | <b>Çıkış</b>   |
|                                   | 1x10-70 mm <sup>2</sup> | 6x2,5-16 mm <sup>2</sup><br>Köprü 1x6-16 mm <sup>2</sup> |
| Ambalaj Adet                      | <b>Paket</b>            | <b>Koli</b>  |
|                                   | 5                       | 160  |



## TEK KUTUPLU DAĞITICI ÜNİTELER

|                                   |                          |  |
|-----------------------------------|--------------------------|--|
| Birim Fiyat<br>TL / Adet          | <b>1.350,00</b>          |  |
| Sipariş Kodu                      | 3711                     |  |
| Ürün Kodu                         | <b>GW - 250A</b>         |  |
| Akım                              | 250 Amper                |  |
| Kablo Kesit<br>(mm <sup>2</sup> ) | <b>Giriş</b>             | <b>Çıkış</b>   |
|                                   | 1x35-120 mm <sup>2</sup> | 4x2,5-10 mm <sup>2</sup><br>5x2,5-16 mm <sup>2</sup><br>2x6-35 mm <sup>2</sup> |
| Ambalaj Adet                      | <b>Paket</b>             | <b>Koli</b>  |
|                                   | 3                        | 54   |



|                                   |                          |  |
|-----------------------------------|--------------------------|--|
| Birim Fiyat<br>TL / Adet          | <b>1.400,00</b>          |  |
| Sipariş Kodu                      | 3712                     |  |
| Ürün Kodu                         | <b>GW - 400A</b>         |  |
| Akım                              | 400 Amper                |  |
| Kablo Kesit<br>(mm <sup>2</sup> ) | <b>Giriş</b>             | <b>Çıkış</b>   |
|                                   | 1x95-185 mm <sup>2</sup> | 4x2,5-10 mm <sup>2</sup><br>5x2,5-16 mm <sup>2</sup><br>2x6-35 mm <sup>2</sup> |
| Ambalaj Adet                      | <b>Paket</b>             | <b>Koli</b>  |
|                                   | 3                        | 54   |



|                                   |                      |  |
|-----------------------------------|----------------------|--|
| Birim Fiyat<br>TL / Adet          | <b>1.550,00</b>      |  |
| Sipariş Kodu                      | 3713                 |  |
| Ürün Kodu                         | <b>GW - 500A</b>     |  |
| Akım                              | 500 Amper            |  |
| Kablo Kesit<br>(mm <sup>2</sup> ) | <b>Giriş</b>         | <b>Çıkış</b>   |
|                                   | 8x24 mm <sup>2</sup> | 4x2,5-10 mm <sup>2</sup><br>5x2,5-16 mm <sup>2</sup><br>2x6-35 mm <sup>2</sup> |
| Ambalaj Adet                      | <b>Paket</b>         | <b>Koli</b>  |
|                                   | 3                    | 54   |





# KOMPAKT KLEMENSLER

## Geçmeli ve Çok Amaçlı



## GEÇMELİ BUAT KLEMENSLER

|   | Sipariş Kodu | Ürün Kodu  | Renk    | Kablo Kesiti               | Ebatlar |      |           | Ambalaj Adet |        | Birim Fiyat TL / Adet |
|---|--------------|------------|---------|----------------------------|---------|------|-----------|--------------|--------|-----------------------|
|   |              |            |         |                            | En      | Boy  | Yükseklik | Paket        | Koli   |                       |
|    | 3501         | GW 2,5 - 2 | Beyaz   | 0,50 - 2,5 mm <sup>2</sup> | 9.8     | 16.4 | 5.8       | 200          | 10.000 | 5,00                  |
|    | 3502         | GW 2,5 - 3 | Turuncu | 0,50 - 2,5 mm <sup>2</sup> | 13.9    | 16.4 | 5.8       | 200          | 10.000 | 5,20                  |
|    | 3503         | GW 2,5 - 4 | Kırmızı | 0,50 - 2,5 mm <sup>2</sup> | 17.9    | 16.4 | 5.8       | 100          | 5.000  | 6,00                  |
|    | 3504         | GW 2,5 - 5 | Sarı    | 0,50 - 2,5 mm <sup>2</sup> | 21.9    | 16.4 | 5.8       | 100          | 5.000  | 7,00                  |
|   | 3505         | GW 2,5 - 6 | Kırmızı | 0,50 - 2,5 mm <sup>2</sup> | 13.8    | 16.4 | 11.25     | 100          | 5.000  | 9,30                  |
|  | 3506         | GW 2,5 - 8 | Gri     | 0,50 - 2,5 mm <sup>2</sup> | 17.8    | 16.4 | 11.25     | 100          | 5.000  | 10,50                 |

Çalışma Sıcaklığı: -30°C + 100°C

Nominal Akım : 24A

Nominal Gerilim : 250V

## ÇOK AMAÇLI KLEMENSLER

|   | Sipariş Kodu | Ürün Kodu | Kablo Kesiti               | Açıklama             | Ambalaj Adet |       | Birim Fiyat TL / Adet |
|---|--------------|-----------|----------------------------|----------------------|--------------|-------|-----------------------|
|   |              |           |                            |                      | Paket        | Koli  |                       |
|  | 3507         | GW - 412  | 0,20 - 4,0 mm <sup>2</sup> | 2 İletken Bağlantılı | 100          | 5.000 | 9,50                  |
|  | 3508         | GW - 413  | 0,20 - 4,0 mm <sup>2</sup> | 3 İletken Bağlantılı | 100          | 5.000 | 12,50                 |
|  | 3509         | GW - 414  | 0,20 - 4,0 mm <sup>2</sup> | 4 İletken Bağlantılı | 50           | 2.500 | 15,20                 |
|  | 3510         | GW - 415  | 0,20 - 4,0 mm <sup>2</sup> | 5 İletken Bağlantılı | 50           | 2.500 | 18,00                 |

Çalışma Sıcaklığı: -40°C + 105°C

Nominal Akım : 24A







Nominal Gerilim : 250V



## RAY MONTAJLI KLEMENSLER

|   | Sipariş Kodu | Ürün Kodu | Tek Telli<br>Kablo Kesiti mm <sup>2</sup> | Çok Telli<br>Kablo Kesiti mm <sup>2</sup> | Ambalaj Adet           |      | Birim Fiyat<br>TL / Adet |
|---|--------------|-----------|---|---|------------------------|------|--------------------------|
|   |              |           |   |   | Paket                  | Koli |                          |
|  | 3511         | GW-4F     | 0.5-4mm <sup>2</sup><br>20-12AWG          | 0.5-2.5mm <sup>2</sup><br>20-14AWG        | 40                     | 2000 | <b>55,00</b>             |
|  | 3512         | GW-6F     | 0.5-6mm <sup>2</sup><br>20-10AWG          | 0.5-4mm <sup>2</sup><br>20-12AWG          | 36                     | 1800 | <b>70,00</b>             |
| Çalışma Sıcaklığı: -40°C + 105°C  |              |           | Nominal Akım : 32A - 40A                  |   | Nominal Gerilim : 450V |      |                          |

(2.5mm<sup>2</sup>) DAĞITIM BLOĞU

|   | Sipariş Kodu | Ürün Kodu  | Kablo Kesiti mm <sup>2</sup>       | Ambalaj Adet |                        | Birim Fiyat<br>TL / Adet |
|---|--------------|------------|------------------------------------|--------------|------------------------|--------------------------|
|   |              |            |                                    | Paket        | Koli                   |                          |
|  | 3513         | GW C2.5-6  | 0.5-2.5mm <sup>2</sup><br>20-14AWG | 30           | 1500                   | <b>75,00</b>             |
|  | 3514         | GW C2.5-8  | 0.5-2.5mm <sup>2</sup><br>20-14AWG | 18           | 900                    | <b>100,00</b>            |
|  | 3515         | GW C2.5-10 | 0.5-2.5mm <sup>2</sup><br>20-14AWG | 18           | 900                    | <b>125,00</b>            |
|  | 3516         | GW C2.5-12 | 0.5-2.5mm <sup>2</sup><br>20-14AWG | 25           | 1250                   | <b>150,00</b>            |
|  | 3517         | GW C2.5-18 | 0.5-2.5mm <sup>2</sup><br>20-14AWG | 12           | 600                    | <b>225,00</b>            |
|  | 3518         | GW C2.5-24 | 0.5-2.5mm <sup>2</sup><br>20-14AWG | 10           | 500                    | <b>300,00</b>            |
| Çalışma Sıcaklığı: -40°C + 105°C  |              |            | Nominal Akım : 32A                 |              | Nominal Gerilim : 450V |                          |

**(2.5mm<sup>2</sup>) RAY MONTAJLI DAĞITIM BLOĞU**

|   | Sipariş Kodu | Ürün Kodu   | Kablo Kesiti mm <sup>2</sup>       | Ambalaj Adet |      | Birim Fiyat TL / Adet |
|---|--------------|-------------|------------------------------------|--------------|------|-----------------------|
|   |              |             |                                    | Paket        | Koli |                       |
|  | 3519         | GW C2.5-12A | 0.5-2.5mm <sup>2</sup><br>20-14AWG | 15           | 750  | <b>165,00</b>         |
|  | 3520         | GW C2.5-18A | 0.5-2.5mm <sup>2</sup><br>20-14AWG | 8            | 400  | <b>240,00</b>         |
|  | 3521         | GW C2.5-24A | 0.5-2.5mm <sup>2</sup><br>20-14AWG | 8            | 400  | <b>315,00</b>         |

Çalışma Sıcaklığı: -40°C + 105°C

Nominal Akım : 32A

Nominal Gerilim : 450V

**6mm<sup>2</sup> BESLEME GİRİŞLİ (2.5mm<sup>2</sup>) DAĞITIM BLOĞU**

|   | Sipariş Kodu | Ürün Kodu   | Besleme Girişi Kablo Kesiti mm <sup>2</sup> | Kablo Kesiti mm <sup>2</sup>       | Ambalaj Adet |      | Birim Fiyat TL / Adet |
|---|--------------|-------------|---|------------------------------------|--------------|------|-----------------------|
|   |              |             |   |                                    | Paket        | Koli |                       |
|  | 3522         | GW6 S2.5-6  | 0.5-6mm <sup>2</sup><br>20-10AWG            | 0.5-2.5mm <sup>2</sup><br>20-14AWG | 18           | 900  | <b>150,00</b>         |
|  | 3523         | GW6 S2.5-12 | 0.5-6mm <sup>2</sup><br>20-10AWG            | 0.5-2.5mm <sup>2</sup><br>20-14AWG | 12           | 600  | <b>225,00</b>         |
|  | 3524         | GW6 S2.5-18 | 0.5-6mm <sup>2</sup><br>20-12AWG            | 0.5-2.5mm <sup>2</sup><br>20-14AWG | 8            | 400  | <b>300,00</b>         |
|  | 3525         | GW6 S2.5-24 | 0.5-6mm <sup>2</sup><br>20-12AWG            | 0.5-2.5mm <sup>2</sup><br>20-14AWG | 8            | 400  | <b>375,00</b>         |

Çalışma Sıcaklığı: -40°C + 105°C

Nominal Akım : 32A

Nominal Gerilim : 450V

**RAY MONTAJ AYAĞI**

|   | Sipariş Kodu | Ürün Kodu | Ürün Açıklaması  | Ambalaj Adet |      | Birim Fiyat TL / Adet |
|---|--------------|-----------|------------------|--------------|------|-----------------------|
|   |              |           |                  | Paket        | Koli |                       |
|  | 3526         | GW-RA     | Ray Montaj Ayağı | 1000         | 5000 | <b>7,50</b>           |



# MAKARON GRUBU

Ve Kablo orabı



[www.guvenelektrik.com.tr](http://www.guvenelektrik.com.tr)

# ISI İLE DARALAN SİYAH MAKARONLAR

## TEKNİK ÖZELLİKLER



Malzeme : Polyolefin Daralma Oranı : 2/1 Voltaj: 600V Yanmazlık : Kendi kendine söner Çalışma Sıcaklığı : -45°C -- +125°C

| Sipariş Kodu | Ölçü  |      | Daralmadan Önce (mm) |                 | Daralmadan Sonra (mm) |                 | Makara / Mt. | Koli Miktarı | Birim Fiyat USD / Mt. |
|--------------|-------|------|----------------------|-----------------|-----------------------|-----------------|--------------|--------------|-----------------------|
|              | Inch  | mm   | İç Çap               | Cidar Kalınlığı | İç Çap                | Cidar Kalınlığı |              |              |                       |
| 4015         | —     | 1    | 2,0 ± 0,3            | 0,16 ± 0,05     | 0,70                  | 0,30 ± 0,05     | 200          | 3.200        | <b>0,085</b>          |
| 4016         | —     | 1,5  | 2,0 ± 0,3            | 0,16 ± 0,05     | 0,80                  | 0,30 ± 0,05     | 200          | 2.400        | <b>0,097</b>          |
| 4017         | —     | 2    | 2,5 ± 0,3            | 0,16 ± 0,05     | 1,00                  | 0,35 ± 0,05     | 200          | 3.000        | <b>0,115</b>          |
| 4003         | 3/32  | 2,4  | 3,0 ± 0,3            | 0,16 ± 0,05     | 1,50                  | 0,35 ± 0,05     | 200          | 3.000        | <b>0,115</b>          |
| 4018         | —     | 2,5  | 3,0 ± 0,3            | 0,16 ± 0,05     | 1,25                  | 0,38 ± 0,05     | 200          | 2.600        | <b>0,15</b>           |
| 4019         | —     | 3    | 3,5 ± 0,4            | 0,20 ± 0,05     | 1,50                  | 0,38 ± 0,05     | 200          | 2.200        | <b>0,16</b>           |
| 4004         | 1/8   | 3,2  | 3,5 ± 0,4            | 0,20 ± 0,05     | 1,75                  | 0,40 ± 0,05     | 200          | 2.200        | <b>0,16</b>           |
| 4020         | —     | 3,5  | 4,0 ± 0,4            | 0,20 ± 0,05     | 1,75                  | 0,40 ± 0,05     | 200          | 1.800        | <b>0,17</b>           |
| 4021         | —     | 4    | 4,5 ± 0,4            | 0,20 ± 0,05     | 2,00                  | 0,45 ± 0,05     | 200          | 1.400        | <b>0,20</b>           |
| 4022         | —     | 4,5  | 4,8 ± 0,4            | 0,20 ± 0,05     | 2,00                  | 0,47 ± 0,08     | 200          | 1.200        | <b>0,23</b>           |
| 4005         | 3/16  | 4,8  | 5,2 ± 0,4            | 0,20 ± 0,05     | 2,60                  | 0,47 ± 0,08     | 200          | 1.200        | <b>0,23</b>           |
| 4023         | —     | 5    | 5,5 ± 0,4            | 0,20 ± 0,05     | 2,50                  | 0,55 ± 0,08     | 200          | 1.000        | <b>0,25</b>           |
| 4024         | —     | 6    | 6,5 ± 0,4            | 0,22 ± 0,05     | 3,00                  | 0,55 ± 0,08     | 200          | 800          | <b>0,29</b>           |
| 4006         | 1/4   | 6,4  | 7,0 ± 0,4            | 0,28 ± 0,05     | 3,50                  | 0,55 ± 0,08     | 200          | 800          | <b>0,29</b>           |
| 4025         | —     | 7    | 7,5 ± 0,4            | 0,28 ± 0,05     | 3,50                  | 0,60 ± 0,08     | 100          | 500          | <b>0,35</b>           |
| 4026         | —     | 8    | 8,5 ± 0,4            | 0,30 ± 0,08     | 4,00                  | 0,60 ± 0,08     | 100          | 1.300        | <b>0,35</b>           |
| 4007         | 3/8   | 9,5  | 10,0 ± 0,5           | 0,30 ± 0,08     | 5,00                  | 0,60 ± 0,08     | 100          | 1.200        | <b>0,35</b>           |
| 4028         | —     | 10   | 10,0 ± 0,5           | 0,30 ± 0,08     | 5,00                  | 0,60 ± 0,08     | 100          | 1.100        | <b>0,39</b>           |
| 4008         | 1/2   | 12,7 | 13,0 ± 0,5           | 0,33 ± 0,10     | 6,50                  | 0,65 ± 0,08     | 100          | 1.000        | <b>0,45</b>           |
| 4031         | —     | 13   | 13,5 ± 0,5           | 0,33 ± 0,10     | 6,50                  | 0,65 ± 0,08     | 100          | 900          | <b>0,48</b>           |
| 4032         | —     | 14   | 14,5 ± 0,5           | 0,33 ± 0,10     | 7,00                  | 0,70 ± 0,08     | 100          | 900          | <b>0,56</b>           |
| 4034         | 4/5   | 16   | 16,5 ± 0,6           | 0,35 ± 0,12     | 8,00                  | 0,75 ± 0,08     | 100          | 800          | <b>0,75</b>           |
| 4036         | —     | 18   | 19,0 ± 0,6           | 0,40 ± 0,15     | 9,00                  | 0,80 ± 0,15     | 100          | 700          | <b>0,98</b>           |
| 4009         | 3/4   | 19,1 | 20,5 ± 0,6           | 0,40 ± 0,15     | 10,00                 | 0,80 ± 0,15     | 100          | 700          | <b>0,98</b>           |
| 4038         | —     | 20   | 20,5 ± 0,6           | 0,40 ± 0,15     | 10,00                 | 0,80 ± 0,15     | 100          | 600          | <b>1,25</b>           |
| 4039         | —     | 22   | 22,5 ± 0,7           | 0,45 ± 0,15     | 12,00                 | 0,95 ± 0,15     | 100          | 600          | <b>1,55</b>           |
| 4010         | 1     | 25,4 | 25,6 ± 0,7           | 0,45 ± 0,15     | 12,00                 | 0,95 ± 0,15     | 50           | 300          | <b>1,65</b>           |
| 4040         | —     | 30   | 31,5 ± 0,7           | 0,50 ± 0,15     | 15,00                 | 0,95 ± 0,15     | 50           | 250          | <b>2,15</b>           |
| 4011         | 1-1/4 | 32   | 33,0 ± 0,7           | 0,50 ± 0,15     | 16,50                 | 0,95 ± 0,15     | 50           | 250          | <b>2,15</b>           |
| 4041         | —     | 35   | 38,0 ± 0,7           | 0,50 ± 0,15     | 16,00                 | 1,00 ± 0,15     | 50           | 200          | <b>2,70</b>           |
| 4012         | 1-1/2 | 38   | 40,0 ± 0,7           | 0,50 ± 0,15     | 20,00                 | 1,00 ± 0,15     | 50           | 200          | <b>3,00</b>           |
| 4042         | —     | 40   | 40,5 ± 0,7           | 0,50 ± 0,15     | 20,00                 | 1,00 ± 0,15     | 50           | 200          | <b>3,00</b>           |
| 4013         | 2     | 51   | 52,5 ± 0,7           | 0,50 ± 0,15     | 25,00                 | 1,00 ± 0,15     | 25           | 125          | <b>3,80</b>           |
| 4043         | —     | 60   | 60,5 ± 0,8           | 0,52 ± 0,15     | 30,00                 | 1,00 ± 0,16     | 25           | 100          | <b>5,10</b>           |
| 4044         | —     | 70   | 70,5 ± 1,0           | 0,55 ± 0,15     | 40,00                 | 1,10 ± 0,18     | 25           | 75           | <b>6,80</b>           |
| 4045         | —     | 80   | 82,0 ± 1,0           | 0,55 ± 0,15     | 40,00                 | 1,10 ± 0,18     | 25           | 75           | <b>7,50</b>           |
| 4050         | —     | 90   | 90,0 ± 1,0           | 0,55 ± 0,15     | 45,00                 | 1,10 ± 0,18     | 25           | 50           | <b>8,50</b>           |
| 4046         | 4     | 102  | 105,0 ± 1,0          | 0,55 ± 0,15     | 51,00                 | 1,10 ± 0,18     | 25           | 50           | <b>9,50</b>           |
| 4047         | —     | 120  | 120,0 ± 1,0          | 0,55 ± 0,15     | 60,00                 | 1,10 ± 0,18     | 25           | 50           | <b>13,00</b>          |
| 4048         | —     | 150  | 150,0 ± 1,0          | 0,55 ± 0,15     | 76,00                 | 1,10 ± 0,18     | 25           | 50           | <b>19,00</b>          |
| 4049         | —     | 180  | 180,0 ± 1,0          | 0,55 ± 0,15     | 90,00                 | 1,10 ± 0,18     | 25           | 25           | <b>27,00</b>          |

## ISI İLE DARALAN RENKLİ MAKARONLAR

ŞEFFAF - BEYAZ - **KIRMIZI** - **MAVİ** - **SARI** - **YEŞİL** - **GRİ**

| Ölçü    |      | Sipariş Kodu |       |         |      |      |       |      | Makara / Mt. | Koli Miktarı | Birim Fiyat USD / Mt. |
|---------|------|--------------|-------|---------|------|------|-------|------|--------------|--------------|-----------------------|
| Inch    | mm   | ŞEFFAF       | BEYAZ | KIRMIZI | MAVİ | SARI | YEŞİL | GRİ  |              |              |                       |
| —       | 1,5  | 4201         | 4289  | 4219    | 4237 | 4254 | 4272  | 4306 | 200          | 3.200        | <b>0,11</b>           |
| —       | 2,5  | 4202         | 4290  | 4220    | 4238 | 4256 | 4273  | 4307 | 200          | 2.600        | <b>0,17</b>           |
| 1/8     | 3,2  | 4203         | 4291  | 4221    | 4239 | 4257 | 4274  | 4308 | 200          | 2.200        | <b>0,20</b>           |
| —       | 3,5  | —            | 4292  | —       | —    | 4258 | —     | —    | 200          | 1.800        | <b>0,21</b>           |
| Yassı   | 3,5  | —            | 4395  | —       | —    | 4390 | —     | —    | 100          | 1.600        | <b>0,21</b>           |
| 3/16    | 4,8  | 4204         | 4293  | 4222    | 4240 | 4259 | 4275  | 4309 | 100          | 1.000        | <b>0,27</b>           |
| Yassı   | 4,8  | —            | 4396  | —       | —    | 4391 | —     | —    | 100          | 1.500        | <b>0,27</b>           |
| 1/4     | 6,4  | 4205         | 4294  | 4224    | 4241 | 4260 | 4276  | 4310 | 100          | 700          | <b>0,33</b>           |
| Yassı   | 6,4  | —            | 4397  | —       | —    | 4392 | —     | —    | 100          | 1.500        | <b>0,33</b>           |
| Yassı   | 7    | —            | 4398  | —       | —    | 4393 | —     | —    | 100          | 1.400        | <b>0,33</b>           |
| 3/8     | 9,5  | 4206         | 4295  | 4226    | 4242 | 4261 | 4278  | 4311 | 100          | 1.200        | <b>0,39</b>           |
| —       | 13   | 4208         | 4296  | 4227    | 4243 | 4262 | 4279  | 4312 | 100          | 900          | <b>0,55</b>           |
| 4/5     | 16   | 4209         | 4297  | 4228    | 4244 | 4263 | 4280  | 4313 | 100          | 800          | <b>0,85</b>           |
| —       | 20   | 4210         | 4298  | 4229    | 4245 | 4264 | 4281  | 4314 | 100          | 600          | <b>1,50</b>           |
| 1       | 25,4 | 4211         | 4299  | 4230    | 4246 | 4265 | 4282  | 4315 | 50           | 300          | <b>1,90</b>           |
| 1 - 1/4 | 32   | 4212         | 4300  | 4231    | 4247 | 4266 | 4283  | 4316 | 50           | 250          | <b>2,40</b>           |
| 1 - 1/2 | 38   | 4213         | 4301  | 4232    | 4248 | 4267 | 4284  | 4317 | 50           | 200          | <b>3,60</b>           |
| 2       | 51   | 4214         | 4302  | 4233    | 4249 | 4268 | 4285  | 4318 | 25           | 125          | <b>4,20</b>           |
| —       | 60   | 4215         | 4303  | 4234    | 4250 | 4269 | 4286  | 4319 | 25           | 100          | <b>5,80</b>           |
| —       | 80   | 4216         | 4304  | 4235    | 4251 | 4270 | 4287  | 4320 | 25           | 75           | <b>8,00</b>           |
| 4       | 102  | 4217         | 4305  | 4236    | 4252 | 4271 | 4288  | 4321 | 25           | 50           | <b>11,00</b>          |



### TEKNİK ÖZELLİKLER

- Malzeme : Polyolefin
- Daralma Oranı : 2/1
- Yanmazlık : Kendi kendine söner
- Çalışma Sıcaklığı : -45°C -- +125°C
- Voltaj : 600V





## ISI İLE DARALAN RENKLİ MAKARONLAR KAHVERENGİ

| Sipariş Kodu | Ölçü  |      | Daralmadan Önce (mm) |                 | Daralmadan Sonra (mm) |                 | Makara / Mt. | Koli Miktarı | Birim Fiyat USD / Mt. |
|--------------|-------|------|----------------------|-----------------|-----------------------|-----------------|--------------|--------------|-----------------------|
|              | Inch  | mm   | İç Çap               | Cidar Kalınlığı | İç Çap                | Cidar Kalınlığı |              |              |                       |
| 4322         | —     | 1,5  | 2,0 ± 0,3            | 0,16 ± 0,05     | 0,80                  | 0,30 ± 0,05     | 200          | 3.200        | <b>0,12</b>           |
| 4323         | —     | 2,5  | 3,0 ± 0,3            | 0,16 ± 0,05     | 1,25                  | 0,38 ± 0,05     | 200          | 2.600        | <b>0,18</b>           |
| 4324         | 1/8   | 3,2  | 3,5 ± 0,4            | 0,20 ± 0,05     | 1,75                  | 0,40 ± 0,05     | 200          | 2.200        | <b>0,22</b>           |
| 4325         | 3/16  | 4,8  | 5,2 ± 0,4            | 0,20 ± 0,05     | 2,60                  | 0,47 ± 0,08     | 100          | 1.000        | <b>0,29</b>           |
| 4326         | 1/4   | 6,4  | 7,0 ± 0,4            | 0,28 ± 0,05     | 3,50                  | 0,55 ± 0,08     | 100          | 700          | <b>0,38</b>           |
| 4327         | 3/8   | 9,5  | 10,0 ± 0,5           | 0,30 ± 0,08     | 5,00                  | 0,60 ± 0,08     | 100          | 1.200        | <b>0,44</b>           |
| 4328         | —     | 13   | 13,5 ± 0,5           | 0,33 ± 0,10     | 6,50                  | 0,65 ± 0,08     | 100          | 900          | <b>0,60</b>           |
| 4329         | 4/5   | 16   | 16,5 ± 0,6           | 0,35 ± 0,12     | 8,00                  | 0,75 ± 0,08     | 100          | 800          | <b>1,05</b>           |
| 4330         | —     | 20   | 20,5 ± 0,6           | 0,40 ± 0,15     | 10,00                 | 0,80 ± 0,15     | 100          | 600          | <b>1,55</b>           |
| 4331         | 1     | 25,4 | 25,6 ± 0,7           | 0,45 ± 0,15     | 12,00                 | 0,95 ± 0,15     | 50           | 300          | <b>2,10</b>           |
| 4332         | 1-1/4 | 32   | 33,0 ± 0,7           | 0,50 ± 0,15     | 16,50                 | 0,95 ± 0,15     | 50           | 250          | <b>2,80</b>           |
| 4333         | 1-1/2 | 38   | 40,0 ± 0,7           | 0,50 ± 0,15     | 20,00                 | 1,00 ± 0,15     | 50           | 200          | <b>4,10</b>           |
| 4334         | 2     | 51   | 52,5 ± 0,7           | 0,50 ± 0,15     | 25,00                 | 1,00 ± 0,15     | 25           | 125          | <b>4,90</b>           |
| 4335         | —     | 60   | 60,5 ± 0,8           | 0,52 ± 0,15     | 30,00                 | 1,00 ± 0,16     | 25           | 100          | <b>7,50</b>           |
| 4336         | —     | 80   | 82,0 ± 1,0           | 0,55 ± 0,15     | 40,00                 | 1,10 ± 0,18     | 25           | 75           | <b>9,00</b>           |
| 4337         | 4     | 102  | 105,0 ± 1,0          | 0,55 ± 0,15     | 51,00                 | 1,10 ± 0,18     | 25           | 50           | <b>13,50</b>          |



### TEKNİK ÖZELLİKLER

- Malzeme : Polyolefin
- Daralma Oranı : 2/1
- Yanmazlık : Kendi kendine söner
- Çalışma Sıcaklığı : -45°C -- +125°C
- Voltaj : 600V



## ISI İLE DARALAN RENKLİ MAKARONLAR

### SARI YEŞİL

| Sipariş Kodu | Ölçü    |      | Daralmadan Önce (mm) |                 | Daralmadan Sonra (mm) |                 | Makara / Mt. | Koli Miktarı | Birim Fiyat USD / Mt. |
|--------------|---------|------|----------------------|-----------------|-----------------------|-----------------|--------------|--------------|-----------------------|
|              | Inch    | mm   | İç Çap               | Cidar Kalınlığı | İç Çap                | Cidar Kalınlığı |              |              |                       |
| 4102         | 3/32    | 2,4  | 3,0 ± 0,3            | 0,16 ± 0,05     | 1,50                  | 0,35 ± 0,05     | 200          | 3.000        | <b>0,42</b>           |
| 4103         | 1/8     | 3,2  | 3,5 ± 0,4            | 0,20 ± 0,05     | 1,75                  | 0,40 ± 0,05     | 200          | 2.200        | <b>0,43</b>           |
| 4104         | 3/16    | 4,8  | 5,2 ± 0,4            | 0,20 ± 0,05     | 2,60                  | 0,47 ± 0,08     | 100          | 1.000        | <b>0,44</b>           |
| 4105         | 1/4     | 6,4  | 7,0 ± 0,4            | 0,28 ± 0,05     | 3,50                  | 0,55 ± 0,08     | 100          | 700          | <b>0,50</b>           |
| 4106         | 3/8     | 9,5  | 10,0 ± 0,5           | 0,30 ± 0,08     | 5,00                  | 0,60 ± 0,08     | 100          | 1.200        | <b>0,68</b>           |
| 4107         | —       | 13   | 13,5 ± 0,5           | 0,33 ± 0,10     | 6,50                  | 0,65 ± 0,08     | 100          | 900          | <b>1,00</b>           |
| 4108         | 4/5     | 16   | 16,5 ± 0,6           | 0,35 ± 0,12     | 8,00                  | 0,75 ± 0,08     | 100          | 800          | <b>1,45</b>           |
| 4109         | —       | 20   | 20,5 ± 0,6           | 0,40 ± 0,15     | 10,00                 | 0,80 ± 0,15     | 100          | 600          | <b>1,90</b>           |
| 4110         | 1       | 25,4 | 25,6 ± 0,7           | 0,45 ± 0,15     | 12,00                 | 0,95 ± 0,15     | 50           | 300          | <b>2,75</b>           |
| 4111         | 1 - 1/4 | 32   | 33,0 ± 0,7           | 0,50 ± 0,15     | 16,50                 | 0,95 ± 0,15     | 50           | 250          | <b>3,70</b>           |
| 4112         | 1 - 1/2 | 38   | 40,0 ± 0,7           | 0,50 ± 0,15     | 20,00                 | 1,00 ± 0,15     | 50           | 200          | <b>5,00</b>           |
| 4113         | 2       | 51   | 52,5 ± 0,7           | 0,50 ± 0,15     | 25,00                 | 1,00 ± 0,15     | 50           | 125          | <b>7,00</b>           |
| 4114         | —       | 60   | 60,5 ± 0,8           | 0,52 ± 0,15     | 30,00                 | 1,00 ± 0,16     | 25           | 100          | <b>10,00</b>          |
| 4115         | —       | 80   | 82,0 ± 1,0           | 0,55 ± 0,15     | 40,00                 | 1,10 ± 0,18     | 25           | 75           | <b>15,00</b>          |
| 4116         | 4       | 102  | 105,0 ± 1,0          | 0,55 ± 0,15     | 51,00                 | 1,10 ± 0,18     | 25           | 50           | <b>23,00</b>          |



### TEKNİK ÖZELLİKLER

- Malzeme : Polyolefin
- Daralma Oranı : 2/1
- Yanmazlık : Kendi kendine söner
- Çalışma Sıcaklığı : -45°C -- +125°C
- Voltaj : 600V



## İÇİ YAPIŞKANLI DARALAN MAKARONLAR

| Sipariş Kodu | Ölçü (mm) | Daralmadan Önce (mm) | Daralmadan Sonra (mm) |                      |                   | Makara / Mt. | Koli Miktarı | Birim Fiyat USD / Mt. |
|--------------|-----------|----------------------|-----------------------|----------------------|-------------------|--------------|--------------|-----------------------|
|              |           | İç Çap               | İç Çap                | Anma Cıdar Kalınlığı | Anma Yayıskanlığı |              |              |                       |
| 4418         | 3/1       | 3.2                  | 1.00                  | 0.90 ± 0.30          | 0.50              | 200          | 1800         | <b>0,65</b>           |
| 4419         | 4.8/1.6   | 4.8                  | 1.60                  | 1.05 ± 0.30          | 0.50              | 100          | 900          | <b>0,80</b>           |
| 4420         | 6/2       | 6.4                  | 2.20                  | 1.25 ± 0.30          | 0.50              | 100          | 600          | <b>1,20</b>           |
| 4421         | 9/3       | 9.5                  | 3.20                  | 1.45 ± 0.30          | 0.60              | 50           | 300          | <b>1,60</b>           |
| 4422         | 12.7/4    | 12.7                 | 4.20                  | 1.65 ± 0.30          | 0.60              | 25           | 250          | <b>2,00</b>           |
| 4424         | 16/5      | 16.0                 | 5.20                  | 1.80 ± 0.30          | 0.60              | 25           | 225          | <b>2,40</b>           |
| 4423         | 19/6      | 19.1                 | 6.30                  | 1.95 ± 0.30          | 0.60              | 25           | 175          | <b>3,50</b>           |
| 4405         | 12/4      | 12.0                 | 4.00                  | 1.40 ± 0.20          | 0.80              | 1.20 Boy     | 250          | <b>2,30</b>           |
| 4406         | 16/5      | 16.0                 | 5.00                  | 1.50 ± 0.20          | 0.80              | 1.20 Boy     | 250          | <b>3,20</b>           |
| 4407         | 19/6      | 19.0                 | 6.00                  | 1.80 ± 0.20          | 0.80              | 1.20 Boy     | 150          | <b>4,50</b>           |
| 4408         | 28/9      | 28.0                 | 9.00                  | 2.40 ± 0.30          | 1.05              | 1.20 Boy     | 110          | <b>5,10</b>           |
| 4409         | 33/10     | 33.0                 | 10.00                 | 2.50 ± 0.30          | 1.05              | 1.20 Boy     | 100          | <b>5,80</b>           |
| 4410         | 40/12     | 40.0                 | 12.00                 | 2.40 ± 0.30          | 1.05              | 1.20 Boy     | 70           | <b>6,40</b>           |
| 4411         | 45/14     | 45.0                 | 14.00                 | 2.40 ± 0.30          | 1.05              | 1.20 Boy     | 60           | <b>7,10</b>           |
| 4412         | 55/16     | 55.0                 | 18.00                 | 2.40 ± 0.30          | 1.05              | 1.20 Boy     | 50           | <b>8,00</b>           |
| 4414         | 70/25     | 70.0                 | 25.00                 | 2.90 ± 0.30          | 1.35              | 1.20 Boy     | 32           | <b>11,30</b>          |
| 4415         | 90/30     | 90.0                 | 30.00                 | 3.00 ± 0.30          | 1.35              | 1.20 Boy     | 24           | <b>16,00</b>          |
| 4416         | 125/40    | 125.0                | 40.00                 | 3.00 ± 0.30          | 1.35              | 1.20 Boy     | 20           | <b>20,00</b>          |



## TEKNİK ÖZELLİKLER

- Malzeme : Polyolefin
- Daralma Oranı : 3/1
- Yanmazlık : Kendi kendine söner
- Çalışma Sıcaklığı : -45°C -- +125°C
- Voltaj : 600V



## KABLO TOPLAMA ÇORABI

| Sipariş Kodu | Ölçü  | Renk  | Esneme Aralığı |          | Makara / Mt. | Birim Fiyat<br>USD / Mt. |
|--------------|-------|-------|----------------|----------|--------------|--------------------------|
|              |       |       | Min (mm)       | Max (mm) |              |                          |
| 4501         | 3 mm  | Siyah | 1              | 6        | 100          | 0,24                     |
| 4502         | 6 mm  | Siyah | 3              | 9        | 100          | 0,29                     |
| 4503         | 8 mm  | Siyah | 5              | 16       | 100          | 0,30                     |
| 4504         | 10 mm | Siyah | 7              | 19       | 100          | 0,36                     |
| 4505         | 12 mm | Siyah | 8              | 24       | 100          | 0,43                     |
| 4506         | 15 mm | Siyah | 10             | 27       | 100          | 0,48                     |
| 4507         | 20 mm | Siyah | 14             | 30       | 100          | 0,56                     |
| 4508         | 25 mm | Siyah | 18             | 35       | 100          | 0,72                     |
| 4509         | 30 mm | Siyah | 20             | 50       | 50           | 0,87                     |
| 4510         | 40 mm | Siyah | 30             | 60       | 50           | 1,14                     |
| 4511         | 50 mm | Siyah | 40             | 80       | 25           | 1,40                     |



## TEKNİK ÖZELLİKLER

- Malzeme : Pet (Polyester)
- Çalışma Sıcaklığı : -50°C -- +150°C
- Dayanım Üst Noktası : 220 °C
- Erime Noktası : +250 °C

## H CLASS CAM ELYAF SİLİKON İZOLELİ MAKARONLAR

| Sipariş Kodu | Ölçü  | Renk    | Makara / Mt. | Koli Miktarı | Birim Fiyat USD / Mt. |
|--------------|-------|---------|--------------|--------------|-----------------------|
| 4703         | 2 mm  | Kırmızı | 200          | 4.000        | <b>0,23</b>           |
| 4705         | 3 mm  | Kırmızı | 100          | 2.500        | <b>0,36</b>           |
| 4706         | 4 mm  | Kırmızı | 100          | 1.500        | <b>0,48</b>           |
| 4707         | 5 mm  | Kırmızı | 100          | 1.200        | <b>0,58</b>           |
| 4708         | 6 mm  | Kırmızı | 100          | 1.000        | <b>0,71</b>           |
| 4709         | 7 mm  | Kırmızı | 100          | 800          | <b>0,82</b>           |
| 4710         | 8 mm  | Kırmızı | 50           | 500          | <b>0,95</b>           |
| 4711         | 10 mm | Kırmızı | 50           | 500          | <b>1,30</b>           |
| 4712         | 12 mm | Kırmızı | 50           | 500          | <b>1,60</b>           |
| 4713         | 14 mm | Kırmızı | 50           | 500          | <b>1,92</b>           |
| 4714         | 16 mm | Kırmızı | 25           | 500          | <b>2,58</b>           |
| 4715         | 18 mm | Kırmızı | 25           | 400          | <b>3,36</b>           |
| 4716         | 20 mm | Kırmızı | 25           | 400          | <b>4,30</b>           |
| 4717         | 25 mm | Kırmızı | 25           | 250          | <b>8,20</b>           |
| 4718         | 30 mm | Kırmızı | 25           | 200          | <b>12,10</b>          |
| 4719         | 35 mm | Kırmızı | 25           | 200          | <b>14,20</b>          |



### TEKNİK ÖZELLİKLER

- Malzeme : Silikon İzoleli Cam Elyaf Örgü Makaron
- Kısa Süre Çalışma Sıcaklığı : -60 °C -- +250 °C
- Sürekli Çalışma Sıcaklığı : -40 °C -- +200 °C





# MEKANİK VE HİDROLİK El Aletleri



## YÜKSÜK SIKMA PENSELERİ

Sipariş Kodu: 5026

Ürün Kodu: GW - B4

0.25 - 6 mm<sup>2</sup> Yüksek Sıkma Pensesi

72,00 USD

Sipariş Kodu: 5006

Ürün Kodu: GW - 6

6 - 16 mm<sup>2</sup> Yüksek Sıkma Pensesi

76,00 USD

Sipariş Kodu: 5005

Ürün Kodu: GW- 5

0.50 - 6 mm<sup>2</sup> Yüksek Sıkma Pensesi

76,00 USD

Sipariş Kodu: 5008

Ürün Kodu: GW - 8

0.08 - 6 mm<sup>2</sup> Yüksek Sıkma Pensesi (4 Köşe)

99,00 USD

Sipariş Kodu: 5009

Ürün Kodu: GW - 9

0.08 - 6 mm<sup>2</sup> Yüksek Sıkma Pensesi (6 Köşe)

115,00 USD

Sipariş Kodu: 5015

Ürün Kodu: GW - 17

25 - 35 mm<sup>2</sup> Yüksek Sıkma Pensesi

80,00 USD

## İZOLESİZ KABLO UCU VE KONNEKTÖR SIKMA PENSELERİ

Sipariş Kodu: 5021

Ürün Kodu: GW - 11

0.50 - 6 mm<sup>2</sup> İzolesiz Terminal Sıkma Pensesi

77,00 USD

Sipariş Kodu: 5022

Ürün Kodu: GW - 12

1.00 - 10 mm<sup>2</sup> İzolesiz Terminal Sıkma Pensesi

77,00 USD

Sipariş Kodu: 5013

Ürün Kodu: GW - 13

28 - 22 / 24 -18 (Molex) Konnektör Ucu Sıkma Pensesi (AWG)



80,00 USD

## İZOLELİ KABLO UCU SIKMA PENSELERİ

Sipariş Kodu: 5016

Ürün Kodu: GW - 1

0.50 - 6 mm<sup>2</sup> İzoleli Kablo Ucu Sıkma Pensesi

65,00 USD

Sipariş Kodu: 5017

Ürün Kodu: GW - 7

0.50 - 6 mm<sup>2</sup> İzoleli Kablo Ucu Sıkma Pensesi

77,00 USD

## MULTİ FONKSİYONEL YÜKSÜK VE KABLO UCU SIKMA PENSESİ

Sipariş Kodu: 5070

Ürün Kodu: T03C - 5D

Takım İçerikli Çanta

### Takım İçeriği

- GW - 5 ..... Yüksük Sıkma 0.5 - 6 mm
- GW - 6 ..... Yüksük Sıkma 6 - 16 mm
- GW - 1 ..... Kablo Ucu Sıkma 0.5 - 6 mm
- GW - 11 ..... İzolesiz Terminal Sıkma 1 - 4mm
- GW - T8 ..... Kaynaklı Papuç Sıkma 0.5 - 10mm



170,00 USD

## KABLO SIYIRMA PENSESİ

Sipariş Kodu: 5028

Ürün Kodu: GW - 318

0.50 - 6 mm<sup>2</sup> Kablo Siyirma Pensesi

36,00 USD

## KABLO BAĞI SIKMA PENSELERİ

Sipariş Kodu: 5054

Ürün Kodu: TG - 008

2.2 - 4.8 mm<sup>2</sup> Kablo Bağı Sıkma Pensesi

71,00 USD

Sipariş Kodu: 5056

Ürün Kodu: TG - 011

4.6 - 12 mm<sup>2</sup> Metal Kablo Bağı Sıkma Pensesi

195,00 USD



## KABLO PABUCU SIKMA PENSELERİ

Sipariş Kodu: 5018

Ürün Kodu: GW - T8

1.5 - 10 mm<sup>2</sup> SKP Sıkma Pensesi

66,00 USD

Sipariş Kodu: 5019

Ürün Kodu: GW - T9

10 - 16 mm<sup>2</sup> SKP Sıkma Pensesi

66,00 USD

## HİDROLİK KABLO PABUCU SIKMA PENSELERİ

Sipariş Kodu: 5052

Ürün Kodu: YQK 70

10 - 70 mm<sup>2</sup> Hidrolik SKP Sıkma Pensesi (Çantalı Set)

120,00 USD

Sipariş Kodu: 5050

Ürün Kodu: YYQ 120

10 - 120 mm<sup>2</sup> Hidrolik SKP Sıkma Pensesi (Çantalı Set)

150,00 USD

Sipariş Kodu: 5051

Ürün Kodu: YQK 300

16 - 300 mm<sup>2</sup> Hidrolik SKP Sıkma Pensesi (Çantalı Set)

160,00 USD



## KABLO KESME MAKASLARI

Sipariş Kodu: 5040

Ürün Kodu: CC- 60

60 mm<sup>2</sup> Kablo Kesme Makası

45,00 USD

Sipariş Kodu: 5041

Ürün Kodu: TC- 100

120 mm<sup>2</sup> Kablo Kesme Makası

76,00 USD

Sipariş Kodu: 5042

Ürün Kodu: TC- 250

250 mm<sup>2</sup> Kablo Kesme Makası

145,00 USD

Sipariş Kodu: 5044

Ürün Kodu: TC - 500

630 mm<sup>2</sup> Kablo Kesme Makası

210,00 USD

Sipariş Kodu: 5067

Ürün Kodu: TCR- 325

325 mm<sup>2</sup> Bakır ve Alüminyum Kablo Kesme Makası

210,00 USD

Sipariş Kodu: 5069

Ürün Kodu: ZCR - 52

500 mm<sup>2</sup> Çok Tellli Kablo Kesme Makası

350,00 USD



# BUTON SERİSİ

## Ve Aksesuarları





## Ø 22mm BUTON SERİSİ YAYLI BUTONLAR

| Sipariş Kodu  | Ürün Kodu | Kontakt | Açıklama | Renk        | Kutu Adet | Koli Adet | Birim Fiyat TL / Ad. |       |
|---|-----------|---------|----------|-------------|-----------|-----------|----------------------|-------|
|  | 6001      | A5 - 10 | 1NO      | Yaylı Buton | Yeşil     | 10        | 300                  | 97,00 |
|   | 6002      | A5 - 01 | 1NC      | Yaylı Buton | Kırmızı   | 10        | 300                  | 97,00 |
|   | 6003      | A5 - 11 | 1NO      | Yaylı Buton | Sarı      | 10        | 300                  | 97,00 |
|   | 6004      | A5 - 21 | 1NO      | Yaylı Buton | Mavi      | 10        | 300                  | 97,00 |
|   | 6005      | A5 - 31 | 1NO      | Yaylı Buton | Beyaz     | 10        | 300                  | 97,00 |
|   | 6006      | A5 - 41 | 1NO      | Yaylı Buton | Siyah     | 10        | 300                  | 97,00 |

## İŞARETLİ YAYLI BUTONLAR

|   |      |           |     |                        |         |    |     |        |
|---|------|-----------|-----|------------------------|---------|----|-----|--------|
|  | 6007 | A5 - 10/1 | 1NO | İşaretlili Yaylı Buton | Yeşil   | 10 | 300 | 115,00 |
|   | 6008 | A5 - 01/2 | 1NC | İşaretlili Yaylı Buton | Kırmızı | 10 | 300 | 115,00 |
|   | 6009 | A5 - 10/3 | 1NO | İşaretlili Yaylı Buton | Mavi    | 10 | 300 | 115,00 |
|   | 6010 | A5 - 10/4 | 1NO | İşaretlili Yaylı Buton | Siyah   | 10 | 300 | 115,00 |

## İŞIKLI YAYLI BUTONLAR

|   |      |              |     |                                  |         |    |     |        |
|---|------|--------------|-----|----------------------------------|---------|----|-----|--------|
|  | 6011 | A5 - 10D     | 1NO | Işıklı Yaylı Buton<br>220V AC/DC | Yeşil   | 10 | 300 | 180,00 |
|   | 6012 | A5 - 01D     | 1NC |                                  | Kırmızı | 10 | 300 | 180,00 |
|   | 6013 | A5 - 11D     | 1NO |                                  | Sarı    | 10 | 300 | 180,00 |
|   | 6014 | A5 - 21D     | 1NO |                                  | Mavi    | 10 | 300 | 180,00 |
|   | 6015 | A5 - 31D     | 1NO |                                  | Beyaz   | 10 | 300 | 180,00 |
|  | 6016 | A5 - 10D-110 | 1NO | Işıklı Yaylı Buton<br>110V AC/DC | Yeşil   | 10 | 300 | 180,00 |
|   | 6017 | A5 - 01D-110 | 1NC |                                  | Kırmızı | 10 | 300 | 180,00 |
|   | 6018 | A5 - 11D-110 | 1NO |                                  | Sarı    | 10 | 300 | 180,00 |
|   | 6019 | A5 - 21D-110 | 1NO |                                  | Mavi    | 10 | 300 | 180,00 |
|   | 6020 | A5 - 31D-110 | 1NO |                                  | Beyaz   | 10 | 300 | 180,00 |
|  | 6021 | A5 - 10D-24  | 1NO | Işıklı Yaylı Buton<br>24V AC/DC  | Yeşil   | 10 | 300 | 180,00 |
|   | 6022 | A5 - 01D-24  | 1NC |                                  | Kırmızı | 10 | 300 | 180,00 |
|   | 6023 | A5 - 11D-24  | 1NO |                                  | Sarı    | 10 | 300 | 180,00 |
|   | 6024 | A5 - 21D-24  | 1NO |                                  | Mavi    | 10 | 300 | 180,00 |
|   | 6025 | A5 - 31D-24  | 1NO |                                  | Beyaz   | 10 | 300 | 180,00 |

## Ø 22mm BUTON SERİSİ

## KALICI MANDAL BUTONLAR

|  | Sipariş Kodu | Ürün Kodu | Kontak             | Açıklama  | Kutu Adet   | Koli Adet | Birim Fiyat TL / Ad. |
|--|--------------|-----------|--------------------|---|---|-----------|----------------------|
|  | 6027         | A5 - 10X  | 1NO                | 0 -1 Mandal Buton   |  | 10        | 300                  |
| 6028   | A5 - 20XS    | 2NO       | 1-0-2 Mandal Buton |  | 10  | 300       | <b>153,00</b>        |



## KAYICI MANDAL BUTONLAR

|  | Sipariş Kodu | Ürün Kodu   | Kontak             | Açıklama   | Kutu Adet   | Koli Adet | Birim Fiyat TL / Ad. |
|---|--------------|-------------|--------------------|--|---|-----------|----------------------|
|   | 6029         | A5 - 10X/FU | 1NO                | 0 -1 Mandal Buton  |  | 10        | 300                  |
| 6030  | A5 - 20XS/FU | 2NO         | 1-0-2 Mandal Buton |  | 10  | 300       | <b>160,00</b>        |

## KALICI - KAYICI MANDAL BUTON





|  | Sipariş Kodu | Ürün Kodu   | Kontak | Açıklama   | Kutu Adet   | Koli Adet | Birim Fiyat TL / Ad. |
|--|--------------|-------------|--------|--|---|-----------|----------------------|
|  | 6026         | A5 - 20XS/F | 2NO    | 1-0-2 Mandal Buton<br>Sağ Pozisyon Kalıcı<br>Sol Pozisyon Kayıcı |  | 10        | 300                  |

## ANAHTARLI KALICI BUTONLAR

|  | Sipariş Kodu | Ürün Kodu | Kontak                | Açıklama  | Kutu Adet   | Koli Adet | Birim Fiyat TL / Ad. |
|--|--------------|-----------|-----------------------|---|---|-----------|----------------------|
|  | 6049         | A5 - 10Y  | 1NO                   | 0 -1 Anahtarlı Buton  |  | 10        | 300                  |
| 6050   | A5 - 20YS    | 2NO       | 1-0-2 Anahtarlı Buton |  | 10  | 300       | <b>205,00</b>        |

## Ø 22mm BUTON SERİSİ



## IŞIKLI KALICI MANDAL BUTONLAR

|   | Sipariş Kodu | Ürün Kodu     | Kontak | Açıklama  | Renk    | Kutu Adet | Koli Adet | Birim Fiyat TL / Ad. |
|---|--------------|---------------|--------|---|---------|-----------|-----------|----------------------|
|    | 6031         | A5 - 10XD     | 1NO    | <br>O-1<br>Işıkli Mandal Buton<br>220V AC/DC     | Yeşil   | 10        | 300       | 180,00               |
|   | 6032         | A5 - 01XD     | 1NC    |   | Kırmızı | 10        | 300       |                      |
|    | 6033         | A5 - 11XD     | 1NO    | <br>O-1<br>Işıkli Mandal Buton<br>24V AC/DC     | Sarı    | 10        | 300       | 180,00               |
|   | 6043         | A5 - 10XD-24  | 1NO    |   | Yeşil   | 10        | 300       |                      |
|  | 6044         | A5 - 01XD-24  | 1NC    | <br>O-1<br>Işıkli Mandal Buton<br>24V AC/DC    | Kırmızı | 10        | 300       | 180,00               |
|   | 6045         | A5 - 11XD-24  | 1NO    |   | Sarı    | 10        | 300       |                      |
|  | 6034         | A5 - 20XSD    | 2NO    | <br>1-O-2<br>Işıkli Mandal Buton<br>220V AC/DC | Yeşil   | 10        | 300       | 220,00               |
|   | 6035         | A5 - 02XSD    | 2NC    |   | Kırmızı | 10        | 300       |                      |
|  | 6036         | A5 - 21XSD    | 2NO    | <br>1-O-2<br>Işıkli Mandal Buton<br>24V AC/DC  | Sarı    | 10        | 300       | 220,00               |
|   | 6046         | A5 - 20XSD-24 | 2NO    |   | Yeşil   | 10        | 300       |                      |
|  | 6047         | A5 - 02XSD-24 | 2NC    | <br>1-O-2<br>Işıkli Mandal Buton<br>24V AC/DC  | Kırmızı | 10        | 300       | 220,00               |
|   | 6048         | A5 - 21XSD-24 | 2NO    |   | Sarı    | 10        | 300       |                      |



## Ø 22mm BUTON SERİSİ

## 40mm KALICI MANTAR BUTON

|  | Sipariş Kodu | Ürün Kodu | Kontakt | Açıklama          | Renk  | Kutu Adet | Koli Adet | Birim Fiyat TL / Ad. |
|---|--------------|-----------|---------|-------------------|---|-----------|-----------|----------------------|
|   | 6054         | A5 - 01ZS | 1NC     | Stop Mantar Buton |  Kırmızı | 10        | 300       | <b>130,00</b>        |

## 40mm KALICI ANAHTARLI MANTAR BUTON

|  |      |           |     |                             |   |    |     |               |
|--|------|-----------|-----|-----------------------------|---|----|-----|---------------|
|  | 6075 | BZ - 01ZA | 1NC | Anahtarlı Stop Mantar Buton |  Kırmızı | 10 | 300 | <b>190,00</b> |
|--|------|-----------|-----|-----------------------------|---|----|-----|---------------|









## 40mm KAYICI MANTAR BUTONLAR

|  |      |          |     |                    |   |    |     |               |
|--|------|----------|-----|--------------------|---|----|-----|---------------|
|  | 6051 | A5 - 01M | 1NC | Stop Mantar Buton  |  Kırmızı | 10 | 300 | <b>115,00</b> |
|  | 6052 | A5 - 10M | 1NO | Start Mantar Buton |  Yeşil   | 10 | 300 | <b>115,00</b> |
|  | 6053 | A5 - 41M | 1NO | Start Mantar Buton |  Siyah   | 10 | 300 | <b>115,00</b> |







## İKİZ BUTONLAR

|  |      |               |         |                              |   |    |     |               |
|--|------|---------------|---------|------------------------------|---|----|-----|---------------|
|  | 6059 | A5 - 11R      | 1NO+1NC | İkiz Buton                   |  Yeşil - Kırmızı | 10 | 300 | <b>185,00</b> |
|  | 6062 | A5 - 11RD     | 1NO+1NC | Işıklı İkiz Buton 220V AC/DC |  Kırmızı - Yeşil | 10 | 300 | <b>250,00</b> |
|  | 6061 | A5 - 11RD-110 | 1NO+1NC | Işıklı İkiz Buton 110V AC/DC |  Kırmızı - Yeşil | 10 | 300 | <b>250,00</b> |
|  | 6060 | A5 - 11RD-24  | 1NO+1NC | Işıklı İkiz Buton 24V AC/DC  |  Kırmızı - Yeşil | 10 | 300 | <b>250,00</b> |

## Ø 22mm BUTON SERİSİ AKSESUARLARI

|   | Sipariş Kodu | Ürün Kodu | Açıklama                             | Kutu Adet | Birim Fiyat TL / Ad. |
|---|--------------|-----------|--------------------------------------|-----------|----------------------|
|    | 6101         | A - 10    | 1NO Start Kontakt                    | 250       | <b>40,00</b>         |
|    | 6102         | A - 01    | 1NC Stop Kontakt                     | 250       | <b>40,00</b>         |
|    | 6103         | A - D2    | BA9S Led Kontakt Yuvası (Buton için) | 200       | <b>48,00</b>         |
|  | 6104         | FC        | Plastik Buton Rozeti                 | 100       | <b>5,70</b>          |
|  | 6105         | FD/60     | 60mm Acil Stop Etiket                | 100       | <b>16,00</b>         |
|  | 6106         | EC5-1     | Acil Stop Butonu Koruma Kapağı       | 20        | <b>95,00</b>         |
|  | 6107         | FH        | Buton Koruma Kapağı                  | 4         | <b>80,00</b>         |
|  | 6108         | BK        | Buton Koruma Kılıfı                  | 100       | <b>12,50</b>         |

## BOŞ KUMANDA KUTULARI





|   | Sipariş Kodu | Ürün Kodu | Açıklama                | Renk       | Kutu Adet | Koli Adet | Birim Fiyat TL / Ad. |
|---|--------------|-----------|-------------------------|------------|-----------|-----------|----------------------|
|    | 6114         | GBK - 1   | 1'li Boş Kumanda Kutusu | Sarı-Siyah | 1         | 100       | <b>67,00</b>         |
|    | 6116         | GBK - 2   | 2'li Boş Kumanda Kutusu | Sarı-Siyah | 1         | 100       | <b>83,00</b>         |
|    | 6118         | GBK - 3   | 3'lü Boş Kumanda Kutusu | Sarı-Siyah | 1         | 100       | <b>107,00</b>        |
|   | 6120         | GBK - 4   | 4'lü Boş Kumanda Kutusu | Sarı-Siyah | 1         | 50        | <b>135,00</b>        |
|  | 6122         | GBK - 5   | 5'li Boş Kumanda Kutusu | Sarı-Siyah | 1         | 50        | <b>200,00</b>        |
|  | 6124         | GBK - 6   | 6'li Boş Kumanda Kutusu | Sarı-Siyah | 1         | 50        | <b>200,00</b>        |

## KUTULU ACİL STOP BUTON

|   | Sipariş Kodu | Ürün Kodu     | Kontakt | Açıklama                    | Renk       | Kutu Adet | Koli Adet | Birim Fiyat TL / Ad. |
|---|--------------|---------------|---------|-----------------------------|------------|-----------|-----------|----------------------|
|  | 6125         | LAY2 - KSE542 | NC      | 1'li Mantar Acil Stop Buton | Sarı-Siyah | 1         | 100       | <b>170,00</b>        |

## VİNÇ KUMANDALARI

### VİNÇ KUMANDALAR

|   | Sipariş Kodu | Ürün Kodu | Açıklama                    | Kutu Adet | Koli Adet | Birim Fiyat TL / Ad. |
|---|--------------|-----------|-----------------------------|-----------|-----------|----------------------|
|    | 6701         | VK - 2    | Vinç Kumanda 2'li Tek Hızlı | 1         | 72        | <b>5,80</b>          |
|    | 6702         | VK - 4    | Vinç Kumanda 4'li Tek Hızlı | 1         | 48        | <b>7,50</b>          |
|    | 6703         | VK - 6    | Vinç Kumanda 6'li Tek Hızlı | 1         | 42        | <b>10,00</b>         |
|  | 6704         | VK - 8    | Vinç Kumanda 8'li Tek Hızlı | 1         | 36        | <b>13,00</b>         |

### ACİL STOPLU VİNÇ KUMANDALAR

|   |      |         |                             |   |    |              |
|---|------|---------|-----------------------------|---|----|--------------|
|  | 6705 | VKB - 3 | Vinç Kumanda 3'li Tek Hızlı | 1 | 50 | <b>23,00</b> |
|  | 6706 | VKB - 5 | Vinç Kumanda 5'li Tek Hızlı | 1 | 40 | <b>32,00</b> |
|  | 6707 | VKB - 7 | Vinç Kumanda 7'li Tek Hızlı | 1 | 30 | <b>41,00</b> |
|  | 6708 | VKB - 9 | Vinç Kumanda 9'li Tek Hızlı | 1 | 20 | <b>50,00</b> |

## Ø 22mm VOLTMETRE

| Sipariş Kodu | Ürün Kodu | Çap (mm) | Açıklama                   | Renk      | Kutu Adet | Koli Adet | Birim Fiyat TL / Ad. |
|--------------|-----------|----------|----------------------------|-----------|-----------|-----------|----------------------|
| 6501         | 22 VS - K | 22       | 24 - 550V Led'li Voltmetre | ● Kırmızı | 10        | 500       | <b>135,00</b>        |
| 6502         | 22 VS - Y | 22       | 24 - 550V Led'li Voltmetre | ● Yeşil   | 10        | 500       | <b>135,00</b>        |
| 6503         | 22 VS - S | 22       | 24 - 550V Led'li Voltmetre | ● Sarı    | 10        | 500       | <b>135,00</b>        |
| 6504         | 22 VS - M | 22       | 24 - 550V Led'li Voltmetre | ● Mavi    | 10        | 500       | <b>135,00</b>        |
| 6505         | 22 VS - B | 22       | 24 - 550V Led'li Voltmetre | ○ Beyaz   | 10        | 500       | <b>135,00</b>        |

## Ø 22mm AMPERMETRE

| Sipariş Kodu | Ürün Kodu | Çap (mm) | Açıklama                                | Renk      | Kutu Adet | Koli Adet | Birim Fiyat TL / Ad. |
|--------------|-----------|----------|---|-----------|-----------|-----------|----------------------|
| 6511         | 22 AS -K  | 22       | 0 - 100A Led'li Ampermetre Akım Trafolu | ● Kırmızı | 10        | 300       | <b>270,00</b>        |
| 6512         | 22 AS -Y  | 22       | 0 - 100A Led'li Ampermetre Akım Trafolu | ● Yeşil   | 10        | 300       | <b>270,00</b>        |
| 6513         | 22 AS -S  | 22       | 0 - 100A Led'li Ampermetre Akım Trafolu | ● Sarı    | 10        | 300       | <b>270,00</b>        |
| 6514         | 22 AS - M | 22       | 0 - 100A Led'li Ampermetre Akım Trafolu | ● Mavi    | 10        | 300       | <b>270,00</b>        |
| 6515         | 22 AS -B  | 22       | 0 - 100A Led'li Ampermetre Akım Trafolu | ○ Beyaz   | 10        | 300       | <b>270,00</b>        |



## Ø 22mm LED'Lİ SİNYALLER



| Sipariş Kodu | Ürün Kodu     | Çap (mm) | Açıklama               | Renk      | Kutu Adet | Koli Adet | Birim Fiyat TL / Ad. |
|--------------|---------------|----------|------------------------|-----------|-----------|-----------|----------------------|
| 6601         | 22 - K        | 22       | Led Sinyal 220V. AC-DC | ● Kırmızı | 10        | 500       | <b>36,00</b>         |
| 6602         | 22 - Y        | 22       |                        | ● Yeşil   | 10        | 500       | <b>36,00</b>         |
| 6603         | 22 - S        | 22       |                        | ● Sarı    | 10        | 500       | <b>36,00</b>         |
| 6604         | 22 - M        | 22       |                        | ● Mavi    | 10        | 500       | <b>36,00</b>         |
| 6605         | 22 - B        | 22       |                        | ○ Beyaz   | 10        | 500       | <b>42,00</b>         |
| 6606         | 22 - 110V - K | 22       | Led Sinyal 110V. AC-DC | ● Kırmızı | 10        | 500       | <b>36,00</b>         |
| 6607         | 22 - 110V - Y | 22       |                        | ● Yeşil   | 10        | 500       | <b>36,00</b>         |
| 6608         | 22 - 110V - S | 22       |                        | ● Sarı    | 10        | 500       | <b>36,00</b>         |
| 6609         | 22 - 110V - M | 22       |                        | ● Mavi    | 10        | 500       | <b>36,00</b>         |
| 6610         | 22 - 110V - B | 22       |                        | ○ Beyaz   | 10        | 500       | <b>42,00</b>         |
| 6611         | 22 - 24V - K  | 22       | Led Sinyal 24V. AC-DC  | ● Kırmızı | 10        | 500       | <b>36,00</b>         |
| 6612         | 22 - 24V - Y  | 22       |                        | ● Yeşil   | 10        | 500       | <b>36,00</b>         |
| 6613         | 22 - 24V - S  | 22       |                        | ● Sarı    | 10        | 500       | <b>36,00</b>         |
| 6614         | 22 - 24V - M  | 22       |                        | ● Mavi    | 10        | 500       | <b>36,00</b>         |
| 6615         | 22 - 24V - B  | 22       |                        | ○ Beyaz   | 10        | 500       | <b>42,00</b>         |

## Ø 16mm LED'Lİ SİNYALLER



| Sipariş Kodu | Ürün Kodu    | Çap (mm) | Açıklama               | Renk      | Kutu Adet | Koli Adet | Birim Fiyat TL / Ad. |
|--------------|--------------|----------|------------------------|-----------|-----------|-----------|----------------------|
| 6621         | 16 - K       | 16       | Led Sinyal 220V. AC-DC | ● Kırmızı | 20        | 1.000     | <b>50,00</b>         |
| 6622         | 16 - Y       | 16       |                        | ● Yeşil   | 20        | 1.000     | <b>50,00</b>         |
| 6623         | 16 - S       | 16       |                        | ● Sarı    | 20        | 1.000     | <b>50,00</b>         |
| 6624         | 16 - M       | 16       |                        | ● Mavi    | 20        | 1.000     | <b>50,00</b>         |
| 6625         | 16 - B       | 16       |                        | ○ Beyaz   | 20        | 1.000     | <b>68,00</b>         |
| 6631         | 16 - 24V - K | 16       | Led Sinyal 24V. AC-DC  | ● Kırmızı | 20        | 1.000     | <b>50,00</b>         |
| 6632         | 16 - 24V - Y | 16       |                        | ● Yeşil   | 20        | 1.000     | <b>50,00</b>         |
| 6633         | 16 - 24V - S | 16       |                        | ● Sarı    | 20        | 1.000     | <b>50,00</b>         |
| 6634         | 16 - 24V - M | 16       |                        | ● Mavi    | 20        | 1.000     | <b>50,00</b>         |
| 6635         | 16 - 24V - B | 16       |                        | ○ Beyaz   | 20        | 1.000     | <b>68,00</b>         |

## BA9S LED AMPULLER



| Sipariş Kodu | Ürün Kodu        | Açıklama              | Renk      | Kutu Adet | Koli Adet | Birim Fiyat TL / Ad. |
|--------------|------------------|-----------------------|-----------|-----------|-----------|----------------------|
| 6521         | BA9SC - K        | Led Ampul 220V. AC-DC | ● Kırmızı | 50        | 4.000     | <b>42,00</b>         |
| 6522         | BA9SC - Y        |                       | ● Yeşil   | 50        | 4.000     | <b>42,00</b>         |
| 6523         | BA9SC - S        |                       | ● Sarı    | 50        | 4.000     | <b>42,00</b>         |
| 6524         | BA9SC - M        |                       | ● Mavi    | 50        | 4.000     | <b>42,00</b>         |
| 6525         | BA9SC - B        |                       | ○ Beyaz   | 50        | 4.000     | <b>52,00</b>         |
| 6526         | BA9SC - 110V - K | Led Ampul 110V. AC-DC | ● Kırmızı | 50        | 4.000     | <b>42,00</b>         |
| 6527         | BA9SC - 110V - Y |                       | ● Yeşil   | 50        | 4.000     | <b>42,00</b>         |
| 6528         | BA9SC - 110V - S |                       | ● Sarı    | 50        | 4.000     | <b>42,00</b>         |
| 6529         | BA9SC - 110V - M |                       | ● Mavi    | 50        | 4.000     | <b>42,00</b>         |
| 6530         | BA9SC - 110V - B |                       | ○ Beyaz   | 50        | 4.000     | <b>52,00</b>         |
| 6531         | BA9SC - 24V - K  | Led Ampul 24V. AC-DC  | ● Kırmızı | 50        | 4.000     | <b>42,00</b>         |
| 6532         | BA9SC - 24V - Y  |                       | ● Yeşil   | 50        | 4.000     | <b>42,00</b>         |
| 6533         | BA9SC - 24V - S  |                       | ● Sarı    | 50        | 4.000     | <b>42,00</b>         |
| 6534         | BA9SC - 24V - M  |                       | ● Mavi    | 50        | 4.000     | <b>42,00</b>         |
| 6535         | BA9SC - 24V - B  |                       | ○ Beyaz   | 50        | 4.000     | <b>52,00</b>         |

## BUZZER'LAR

## Ø 22mm LED'Lİ BUZZERLAR (90dB)



| Sipariş Kodu | Ürün Kodu | Çap (mm) | Açıklama                              | Renk      | Kutu Adet | Koli Adet | Birim Fiyat TL / Ad. |
|--------------|-----------|----------|---------------------------------------|-----------|-----------|-----------|----------------------|
| 6640         | 22DS/MS   | 22       | Sesli Led Flaşör İkazlı<br>220V. AC   | ● Kırmızı | 10        | 500       | 150,00               |
| 6641         | 22DS/MS24 | 22       | Sesli Led Flaşör İkazlı<br>24V. AC/DC | ● Kırmızı | 10        | 500       | 150,00               |

## MOTORLU SİRENLER



| Sipariş Kodu | Ürün Kodu     | Açıklama                                | Kutu Adet | Koli Adet | Birim Fiyat TL / Ad. |
|--------------|---------------|---|-----------|-----------|----------------------|
| 6651         | MS - 190      | 75mm Metal Gövde 220V. AC (110 - 130dB) | 1         | 40        | 600,00               |
| 6652         | MS - 190 - 24 | 75mm Metal Gövde 24V. DC (110 - 130dB)  | 1         | 40        | 600,00               |

## PANO İÇİ TERMOSTATLAR

**Çalışma Ömrü** : 100.000 Açma Kapama  
**Ölçüler** : 60x33x43  
**Ağırlık** : 40 gr  
**Koruma Sınıfı** : IP20



| Sipariş Kodu | Ürün Kodu | Kontak | Açıklama ve Çalışma Sıcaklığı   | Kutu Adet | Koli Adet | Birim Fiyat TL / Ad. |
|--------------|-----------|--------|---------------------------------|-----------|-----------|----------------------|
| 6682         | KTO - 011 | NC     | Isıtma Termostatı ( 0 - 60°C )  | 1         | 200       | 230,00               |
| 6681         | KTS - 011 | NO     | Soğutma Termostatı ( 0 - 60°C ) | 1         | 200       | 230,00               |

## Ø 22mm POTANSİYOMETRE

|   |                      |                                      |
|---|----------------------|--------------------------------------|
|  | Birim Fiyat TL / Ad. | <b>210,00</b>                        |
|   | Sipariş Kodu         | 6665                                 |
|   | Ürün Kodu            | APT22 - 5K                           |
|   | Çap (mm)             | 22                                   |
|   | Kutu Adet            | 10                                   |
|   | Koli Adet            | 500                                  |
|   | Açıklama             | 5K Potansiyometre Tek Turlu 220V. AC |

|  |                      |                                       |
|--|----------------------|---------------------------------------|
|  | Birim Fiyat TL / Ad. | <b>210,00</b>                         |
|  | Sipariş Kodu         | 6666                                  |
|  | Ürün Kodu            | APT22 - 10K                           |
|  | Çap (mm)             | 22                                    |
|  | Kutu Adet            | 10                                    |
|  | Koli Adet            | 500                                   |
|  | Açıklama             | 10K Potansiyometre Tek Turlu 220V. AC |

## AKS SERİSİ KAPI SWITCH



| Sipariş Kodu | Ürün Kodu | Kontak | Açıklama                  | Kutu Adet | Koli Adet | Birim Fiyat TL / Ad. |
|--------------|-----------|--------|---------------------------|-----------|-----------|----------------------|
| 6825         | AKS - 10  | NO     | Açık Kontak Kapi Switch   | 50        | 500       | <b>55,00</b>         |
| 6826         | AKS - 01  | NC     | Kapalı Kontak Kapi Switch | 50        | 500       | <b>55,00</b>         |



# SWITCH GRUBU

## GLS - AZ - GMS Serisi





## GLS SERİSİ LİMİT SWITCH

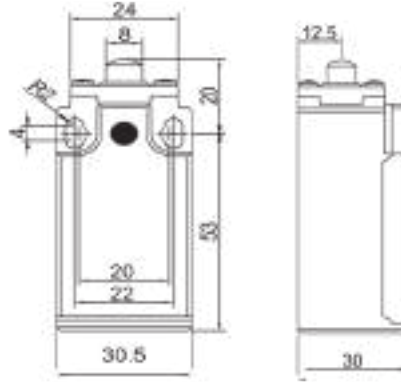

| Birim Fiyat USD / Ad. | 7,20 \$                           |
|-----------------------|-----------------------------------|
| Sipariş Kodu          | 6801                              |
| Ürün Kodu             | GLS -101                          |
| Kutu Adet             | 10                                |
| Koli Adet             | 100                               |
| Açıklama              | Kısa Dikey Metal Pim<br>1NO + 1NC |

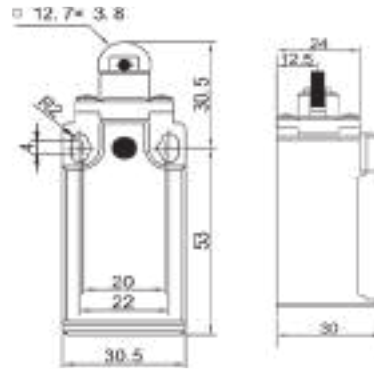

| Birim Fiyat USD / Ad. | 7,20 \$                           |
|-----------------------|-----------------------------------|
| Sipariş Kodu          | 6802                              |
| Ürün Kodu             | GLS -103                          |
| Kutu Adet             | 10                                |
| Koli Adet             | 100                               |
| Açıklama              | Dikey Metal Makaralı<br>1NO + 1NC |

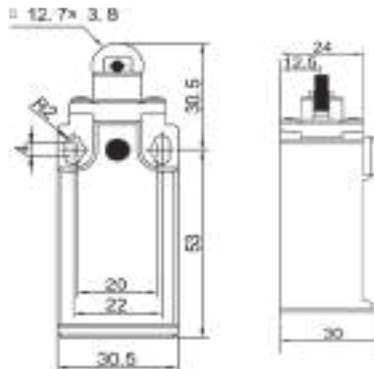

| Birim Fiyat USD / Ad. | 7,70 \$                                   |
|-----------------------|---|
| Sipariş Kodu          | 6803                                      |
| Ürün Kodu             | GLS -103R                                 |
| Kutu Adet             | 10  |
| Koli Adet             | 100                                       |
| Açıklama              | Dikey Metal Makaralı Resetli<br>1NO + 1NC |

**RESETLİ**

## GLS SERİSİ LİMİT SWITCH

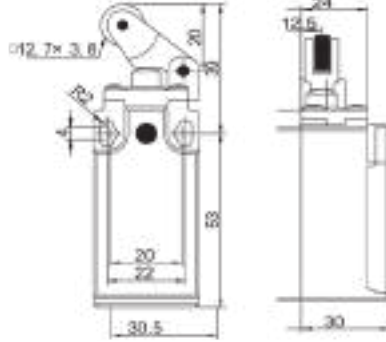

| Birim Fiyat<br>USD / Ad. | 7,20 \$                                    |
|--------------------------|--|
| Sipariş Kodu             | 6804                                       |
| Ürün Kodu                | GLS -111                                   |
| Kutu Adet                | 10   |
| Koli Adet                | 100  |
| Açıklama                 | Açısal Metal Makaralı Tek Yön<br>1NO + 1NC |

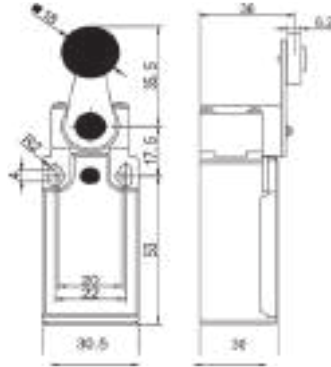

| Birim Fiyat<br>USD / Ad. | 7,20 \$                                    |
|--------------------------|--|
| Sipariş Kodu             | 6805                                       |
| Ürün Kodu                | GLS -121                                   |
| Kutu Adet                | 10   |
| Koli Adet                | 100  |
| Açıklama                 | Dikey Metal Makaralı Çift Yön<br>1NO + 1NC |

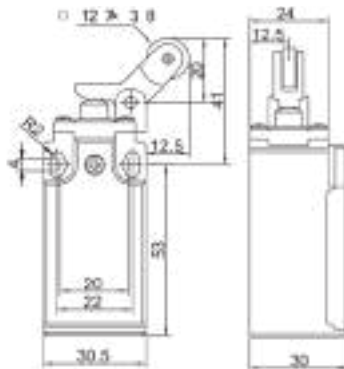

| Birim Fiyat<br>USD / Ad. | 7,20 \$   |
|--------------------------|---|
| Sipariş Kodu             | 6806  |
| Ürün Kodu                | GLS -127  |
| Kutu Adet                | 10  |
| Koli Adet                | 100   |
| Açıklama                 | Ters Açısal Metal Makaralı Tek<br>Yön 1NO + 1NC |

## GLS SERİSİ LİMİT SWITCH

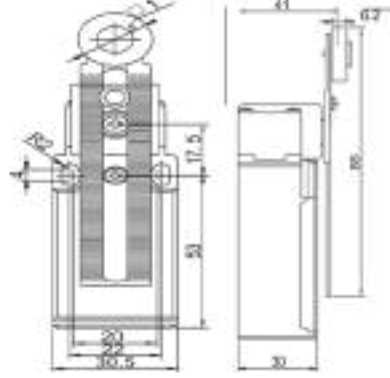

| Birim Fiyat USD / Ad. | 7,50 \$   |
|-----------------------|---|
| Sipariş Kodu          | 6807  |
| Ürün Kodu             | GLS -131  |
| Kutu Adet             | 10  |
| Koli Adet             | 100   |
| Açıklama              | Ayarlanabilir Metal Makaralı Çift Yön İNO + İNC |

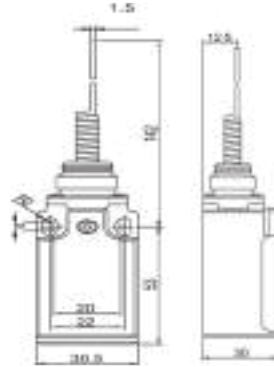

| Birim Fiyat USD / Ad. | 7,50 \$                           |
|-----------------------|-----------------------------------|
| Sipariş Kodu          | 6808                              |
| Ürün Kodu             | GLS -161                          |
| Kutu Adet             | 10                                |
| Koli Adet             | 100                               |
| Açıklama              | Çok Yönlü Spiral Tel Uç İNO + İNC |

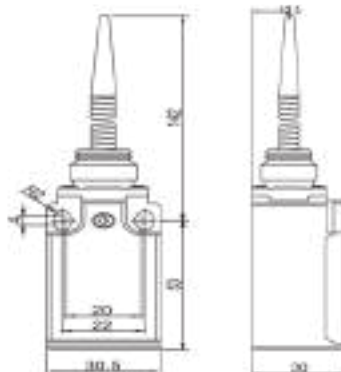

| Birim Fiyat USD / Ad. | 7,50 \$                               |
|-----------------------|---------------------------------------|
| Sipariş Kodu          | 6809                                  |
| Ürün Kodu             | GLS -171                              |
| Kutu Adet             | 10                                    |
| Koli Adet             | 100                                   |
| Açıklama              | Çok Yönlü Spiral Plastik Uç İNO + İNC |





## AZ SERİSİ MİKRO SWITCH

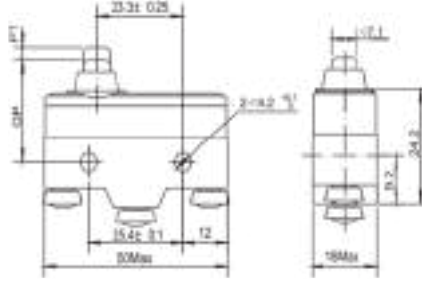

|                       |                                   |
|-----------------------|-----------------------------------|
| Birim Fiyat USD / Ad. | <b>4,25 \$</b>                    |
| Sipariş Kodu          | 6812                              |
| Ürün Kodu             | AZ - 15GD - B                     |
| Kutu Adet             | 20                                |
| Koli Adet             | 360                               |
| Açıklama              | Kalın Uzun Pimli 15A<br>1NO + 1NC |

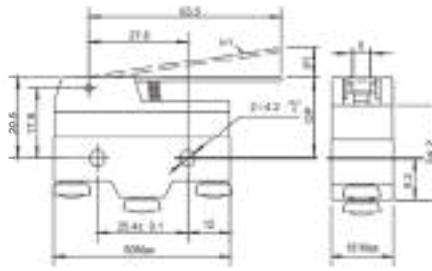

|                       |                             |
|-----------------------|-----------------------------|
| Birim Fiyat USD / Ad. | <b>4,25 \$</b>              |
| Sipariş Kodu          | 6814                        |
| Ürün Kodu             | AZ - 15GW - B               |
| Kutu Adet             | 20                          |
| Koli Adet             | 360                         |
| Açıklama              | Uzun Palet 15A<br>1NO + 1NC |

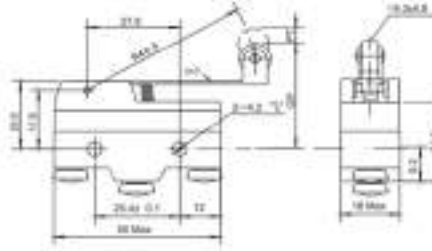

|                       |  |
|-----------------------|--|
| Birim Fiyat USD / Ad. | <b>4,60 \$</b>                             |
| Sipariş Kodu          | 6815                                       |
| Ürün Kodu             | AZ - 15GW2 - B                             |
| Kutu Adet             | 20   |
| Koli Adet             | 360  |
| Açıklama              | Uzun Palet Metal Makaralı<br>15A 1NO + 1NC |

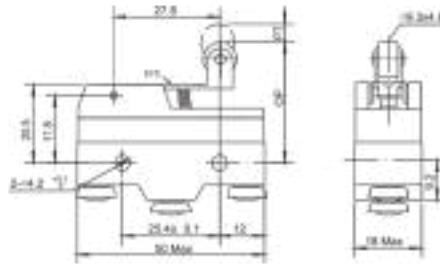

|                       |                                      |
|-----------------------|--------------------------------------|
| Birim Fiyat USD / Ad. | <b>4,60 \$</b>                       |
| Sipariş Kodu          | 6818                                 |
| Ürün Kodu             | AZ - 15GW22 - B                      |
| Kutu Adet             | 20                                   |
| Koli Adet             | 360                                  |
| Açıklama              | Kısa Metal Makaralı 15A<br>1NO + 1NC |

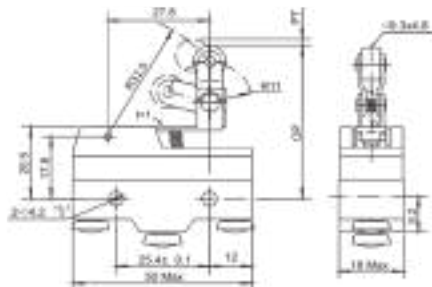

|                       |  |
|-----------------------|--|
| Birim Fiyat USD / Ad. | <b>5,10 \$</b>                           |
| Sipariş Kodu          | 6819                                     |
| Ürün Kodu             | AZ - 15GW2277 - B                        |
| Kutu Adet             | 20                                       |
| Koli Adet             | 360                                      |
| Açıklama              | Tahrikli Metal Makaralı<br>15A 1NO + 1NC |





## GMS SERİSİ MİKRO SWITCH



|                       |   |           |            |
|-----------------------|---|-----------|------------|
| Birim Fiyat USD / Ad. | 1,15 \$   |           |            |
| Sipariş Kodu          | 6830  | Ürün Kodu | GMS - 100C |
| Kutu Adet             | 100   | Koli Adet | 1.800      |
| Açıklama              | 10 Amper Plastik Pimli Mikro Switch             |           |            |
| Birim Fiyat USD / Ad. | 1,22 \$   |           |            |
| Sipariş Kodu          | 6831  | Ürün Kodu | GMS - 101C |
| Kutu Adet             | 100   | Koli Adet | 1.800      |
| Açıklama              | 10 Amper Orta Kollu Mikro Switch                |           |            |
| Birim Fiyat USD / Ad. | 1,22 \$   |           |            |
| Sipariş Kodu          | 6832  | Ürün Kodu | GMS - 102C |
| Kutu Adet             | 100   | Koli Adet | 1.800      |
| Açıklama              | 10 Amper Kısa Kollu Mikro Switch                |           |            |
| Birim Fiyat USD / Ad. | 1,38 \$   |           |            |
| Sipariş Kodu          | 6833  | Ürün Kodu | GMS - 103C |
| Kutu Adet             | 100   | Koli Adet | 1.800      |
| Açıklama              | 10 Amper Uzun Kollu Metal Makaralı Mikro Switch |           |            |
| Birim Fiyat USD / Ad. | 1,38 \$   |           |            |
| Sipariş Kodu          | 6834  | Ürün Kodu | GMS - 104C |
| Kutu Adet             | 100   | Koli Adet | 1.800      |
| Açıklama              | 10 Amper Kısa Kollu Metal Makaralı Mikro Switch |           |            |
| Birim Fiyat USD / Ad. | 1,38 \$   |           |            |
| Sipariş Kodu          | 6835  | Ürün Kodu | GMS - 105C |
| Kutu Adet             | 100   | Koli Adet | 1.800      |
| Açıklama              | 10 Amper Uzun Kollu Mikro Switch                |           |            |
| Birim Fiyat USD / Ad. | 1,38 \$   |           |            |
| Sipariş Kodu          | 6836  | Ürün Kodu | GMS - 106C |
| Kutu Adet             | 100   | Koli Adet | 1.800      |
| Açıklama              | 10 Amper Kıvrık Kollu Mikro Switch              |           |            |

## AYAK PEDALLARI

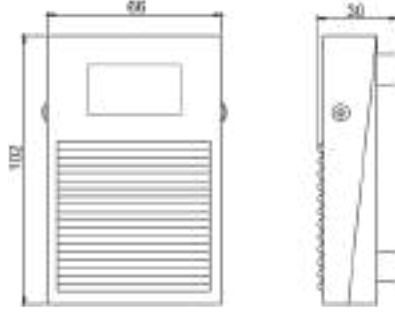

|                          |                                  |
|--------------------------|----------------------------------|
| Birim Fiyat<br>USD / Ad. | <b>8,50 \$</b>                   |
| Sipariş Kodu             | 6901                             |
| Ürün Kodu                | AP - 1                           |
| Kutu Adet                | 1                                |
| Koli Adet                | 60                               |
| Açıklama                 | Metal Döküm Pedal<br>2mt Kablolu |

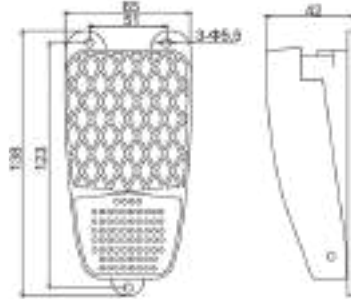

|                          |                                      |
|--------------------------|--------------------------------------|
| Birim Fiyat<br>USD / Ad. | <b>12,00 \$</b>                      |
| Sipariş Kodu             | 6902                                 |
| Ürün Kodu                | AP - 2                               |
| Kutu Adet                | 1                                    |
| Koli Adet                | 60                                   |
| Açıklama                 | Alüminyum Döküm Pedal<br>1mt Kablolu |

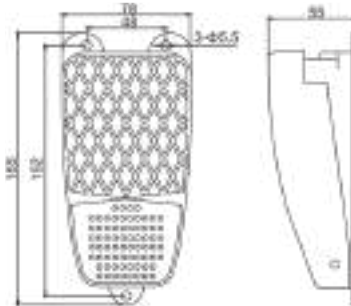

|                          |                                      |
|--------------------------|--------------------------------------|
| Birim Fiyat<br>USD / Ad. | <b>15,50 \$</b>                      |
| Sipariş Kodu             | 6903                                 |
| Ürün Kodu                | AP - 3                               |
| Kutu Adet                | 1                                    |
| Koli Adet                | 40                                   |
| Açıklama                 | Alüminyum Döküm Pedal<br>1mt Kablolu |

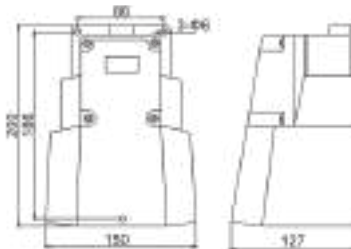

|                          |                   |
|--------------------------|-------------------|
| Birim Fiyat<br>USD / Ad. | <b>38,50 \$</b>   |
| Sipariş Kodu             | 6904              |
| Ürün Kodu                | AP - 9            |
| Kutu Adet                | 1                 |
| Koli Adet                | 12                |
| Açıklama                 | Metal Döküm Pedal |



**GÜVEN**  
ELEKTRİK ELEKTRONİK LTD. ŞTİ.

**GWEST**®

**W**WOER®

**Başarılar  
Karşılıklı Güven'e Bağlıdır.**

**MERKEZ:**

İkitelli Organize Sanayi Bölgesi  
Mutsan Sanayi Sitesi M12 Blok No: 52-54  
Başakşehir / İstanbul  
Tel: 0212 485 05 40  
Fax: 0212 486 05 61

**İMALAT:**

İkitelli Organize Sanayi Bölgesi  
Mutsan Sanayi Sitesi M5 Blok No: 2-12  
Başakşehir / İstanbul  
Tel: 0212 361 69 61  
Fax: 0212 361 69 63